



Model 74621 Model 73621



Features

- Complete radar and software radio interface solution
- Supports Xilinx Virtex-6 LXT and SXT FPGAs
- Three or six 200 MHz 16-bit A/Ds
- Three or six multiband DDCs (digital downconverters)
- One or two DUCs (digital upconverters)
- Two or four 800 MHz 16-bit D/As
- One or two multiboard programmable beamformers
- Up to 2 or 4 GB of DDR3 SDRAM; or: 32 MB or 64MB of QDRII+ SRAM
- Sample clock synchronization to an external system reference
- LVPECL clock/sync bus for multiboard synchronization

General Information

Models 72621, 73621 and 74621 are members of the Cobalt® family of high performance CompactPCI boards based on the Xilinx Virtex-6 FPGA. They consist of one or two Model 71621 XMC modules mounted on a cPCI carrier board.

Model 72621 is a 6U cPCI board while the Model 73621 is a 3U cPCI board; both are equipped with one Model 71621 XMC. Model 74621 is a 6U cPCI board with two XMC modules rather than one.

These models include three or six A/Ds, three or six multiband DDCs, one or two DUCs, two or four D/As and four or eight banks of memory.

The Cobalt Architecture

The Pentek Cobalt Architecture features a Virtex-6 FPGA. All of the board's data and control paths are accessible by the FPGA, enabling factory-installed functions including data multiplexing, channel selection, data packing, gating, triggering and memory control. The Cobalt Architecture organizes the FPGA as a container for data processing applications where each function exists as an intellectual property (IP) module.

Each member of the Cobalt family is delivered with factory-installed applications ideally matched to the board's analog interfaces. The factory-installed functions of these models include three or six A/D acquisition and one or two D/A waveform playback IP modules. Each of the acquisition IP modules contains a powerful, programmable DDC IP core. The waveform playback IP module contains an interpolation IP core,

ideal for matching playback rates to the data and decimation rates of the acquisition modules. IP modules for either DDR3 or QDRII+ memories, controllers for all data clocking and synchronization functions, a test signal generator, a programmable beamforming IP core, an Aurora gigabit serial interface, and a PCIe interface complete the factory-installed functions and enable these models to operate as complete turnkey solutions, without the need to develop any FPGA IP.

Extendable IP Design

For applications that require specialized function, users can install their own custom IP for data processing. Pentek GateFlow FPGA Design Kits include all of the factory-installed modules as documented source code. Developers can integrate their own IP with the Pentek factory-installed functions or use the GateFlow kit to completely replace the Pentek IP with their own.

Xilinx Virtex-6 FPGA

The Virtex-6 FPGA site can be populated with two different FPGAs to match the specific requirements of the processing task. Supported FPGAs include: LX240T or SX315T. The SXT part features 1344 DSP48E slices and is ideal for modulation/demodulation, encoding/decoding, encryption/decryption, and channelization of the signals between transmission and reception. For applications not requiring large DSP resources, the lower-cost LXT FPGA can be installed. ➤

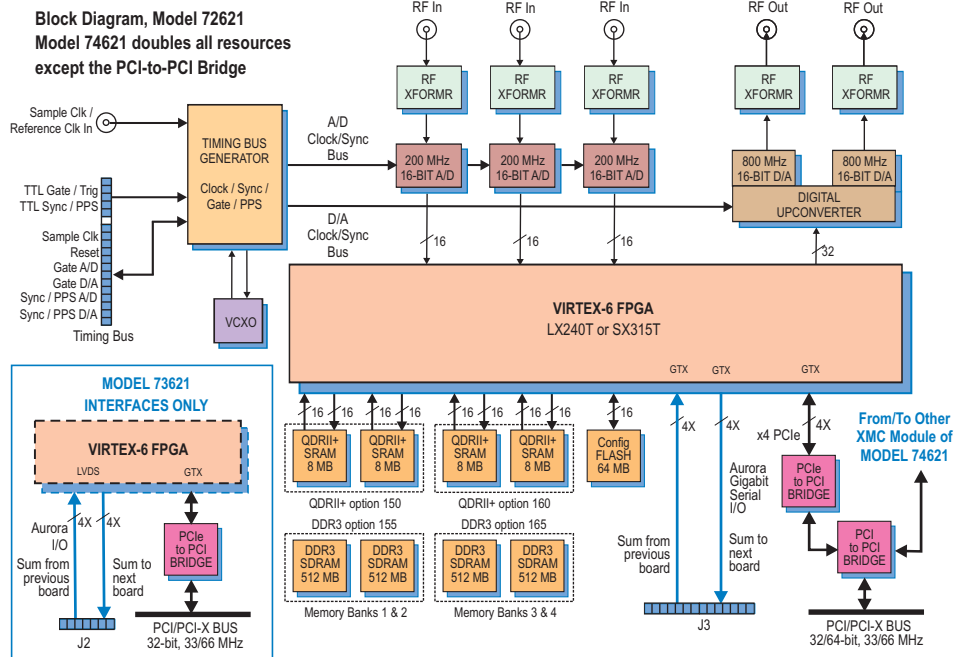

► **A/D Acquisition IP Modules**

These models feature three or six A/D Acquisition IP Modules for easily capturing and moving data. Each module can receive data from any of the three A/Ds, a test signal generator or from the D/A Waveform Playback IP Module in loopback mode.

Each IP module has an associated memory bank for buffering data in FIFO mode or for storing data in transient capture mode. All memory banks are supported with DMA engines for easily moving A/D data through the PCIe interface.

These powerful linked-list DMA engines are capable of a unique Acquisition Gate Driven mode. In this mode, the length of a transfer performed by a link definition need not be known prior to data acquisition; rather, it is governed by the length of the acquisition gate. This is extremely useful in applications where an external gate drives acquisition and the exact length of that gate is not known or is likely to vary.

For each transfer, the DMA engine can automatically construct metadata packets containing A/D channel ID, a sample-accurate time stamp and data length information. These actions simplify the host processor's job of identifying and executing on the data.

DDC IP Cores

Within each A/D Acquisition IP Module is a powerful DDC IP core. Because of the flexible input routing of the A/D Acquisition IP Modules, many different configurations can be achieved including one A/D driving all three DDCs or each of the three A/Ds driving its own DDC.

Each DDC has an independent 32-bit tuning frequency setting that ranges from DC to f_s , where f_s is the A/D sampling frequency. Each DDC can have its own unique decimation setting, supporting as many as three different output bandwidths for the board. Decimations can be programmed from 2 to 65,536 providing a wide range to satisfy most applications.

The decimating filter for each DDC accepts a unique set of user-supplied 18-bit coefficients. The 80% default filters deliver an output bandwidth of $0.8 * f_s / N$, where N is the decimation setting. The rejection of adjacent-band components within the 80% output bandwidth is better than 100 dB. Each DDC delivers a complex output stream consisting of 24-bit I + 24-bit Q or 16-bit I + 16-bit Q samples at a rate of f_s / N .

Beamformer IP Cores

In addition to the DDCs, these models feature one or two complete beamforming subsystems. Each DDC core contains programmable I & Q phase and gain adjustments followed by a power meter that continuously measures the individual average power output. The time constant of the averaging interval for each meter is programmable up to 8K samples. The power meters present average power measurements for each DDC core output in easy-to-read registers.

In addition, each DDC core includes a threshold detector to automatically send an interrupt to the processor if the average power level of any DDC core falls below or exceeds a programmable threshold.

A programmable summation block provides summing of any of the three DDC core outputs. An additional programmable gain stage compensates for summation change bit growth. A power meter and threshold detect block is provided for the summed output. The output is then directed back into the A/D Acquisition IP Module 1 FIFO for reading over the PCIe. For larger systems, multiple boards can be chained together via the built-in Xilinx Aurora gigabit serial interfaces through the J3 and J5 connectors. This allows summation across channels on multiple boards.

D/A Waveform Playback IP Modules

The factory-installed functions include sophisticated D/A Waveform Playback IP modules. Linked-list controllers allow users to easily play back to the dual D/As waveforms stored in either on-board memory or off-board host memory.

Parameters including length of waveform, delay from playback trigger, waveform repetition, etc. can be programmed for each waveform.

Up to 64 or 128 individual link entries can be chained together to create complex waveforms with a minimum of programming. ►

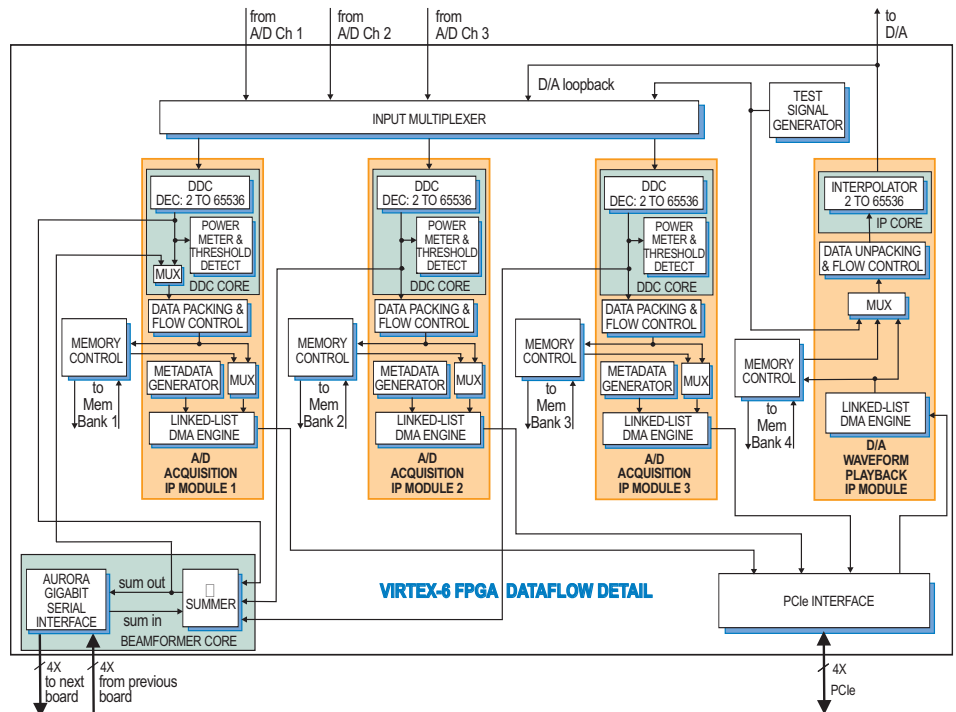

► A/D Converter Stage

The front end accepts three or six analog HF or IF inputs on front panel SSMC connectors with transformer coupling into three or six Texas Instruments ADS5485 200 MHz, 16-bit A/D converters.

The digital outputs are delivered into the Virtex-6 FPGA for signal processing, data capture and for routing to other module resources.

Digital Upconverter and D/A Stage

One or two TI DAC5688 DUCs (digital upconverters) and D/As accept baseband real or complex data streams from the FPGA and provide that input to the upconvert, interpolate and dual D/A stages.

When operating as a DUC, it interpolates and translates real or complex baseband input signals to any IF center frequency up to 360 MHz. It delivers real or quadrature (I+Q) analog outputs to the dual 16-bit D/A converter. Analog output is through front panel SSMC connectors.

If translation is disabled, the DAC5688 acts as a dual interpolating 16-bit D/A with output sampling rates up to 800 MHz. In both modes the DAC5688 provides interpolation factors of 2x, 4x and 8x. In addition to the DAC5688, an FPGA based interpolator core provides additional interpolation from 2x to 65,536x. The two interpolators can be combined to create a total range from 2x to 524,288x.

Clocking and Synchronization

Two internal timing buses provide either a single clock or two different clock rates to the A/D and D/A signal paths.

Each timing bus includes a clock, sync and a gate or trigger signal. An on-board clock generator receives an external sample clock from the front panel SSMC connector. This clock can be used directly for either the A/D or D/A sections or can be divided by a built-in clock synthesizer circuit to provide different A/D and D/A clocks. In an alter-

nate mode, the sample clock can be sourced from an on-board programmable VCXO (Voltage-Controlled Crystal Oscillator). In this mode, the front panel SSMC connector can be used to provide a 10 MHz reference clock for synchronizing the internal oscillator.

A front panel 26-pin LVPECL Clock/Sync connector allows multiple boards to be synchronized. In the slave mode, it accepts LVPECL inputs that drive the clock, sync and gate signals. In the master mode, the LVPECL bus can drive the timing signals for synchronizing multiple boards.

Multiple boards can be driven from the LVPECL bus master, supporting synchronous sampling and sync functions across all connected boards.

Memory Resources

The Cobalt architecture supports up to four or eight independent memory banks which can be configured with all QDRII+ SRAM, DDR3 SDRAM, or as combination of two banks of each type of memory.

Each QDRII+ SRAM bank can be up to 8 MB deep and is an integral part of the module's DMA capabilities, providing FIFO memory space for creating DMA packets. For applications requiring deep memory resources, DDR3 SDRAM banks can each be up to 512 MB deep. Built-in memory functions include an A/D data transient capture mode and D/A waveform playback mode.

In addition to the factory-installed functions, custom user-installed IP within the FPGA can take advantage of the memories for many other purposes.

PCI-X Interface

These models include an industry-standard interface fully compliant with PCI-X bus specifications. The interface includes multiple DMA controllers for efficient transfers to and from the board. Data widths of 32 or 64 bits and data rates of 33 and 66 MHz are supported. Model 73621: 32 bits only. ►

► **Specifications**

Model 72621 or Model 73621: 3 A/Ds,
3 DDCs, 1 DUC, 2 D/As

Model 74621: 6 A/Ds, 6 DDCs, 2 DUCs,
4 D/As

Front Panel Analog Signal Inputs (3 or 6)

Input Type: Transformer-coupled, front
panel female SSMC connectors

Transformer Type: Coil Craft
WBC4-6TLB

Full Scale Input: +8 dBm into 50 ohms
3 dB Passband: 300 kHz to 700 MHz

A/D Converters (3 or 6)

Type: Texas Instruments ADS5485

Sampling Rate: 10 MHz to 200 MHz

Resolution: 16 bits

Digital Downconverters (3 or 6)

Decimation Range: 2x to 65,536x in two
stages of 2x to 256x

LO Tuning Freq. Resolution: 32 bits,
0 to f_s

LO SFDR: >120 dB

Phase Offset Resolution: 32 bits,
0 to 360 degrees

FIR Filter: 18-bit coefficients, 24-bit output,
with user programmable coefficients

Default Filter Set: 80% bandwidth, <0.3
dB passband ripple, >100 dB stopband
attenuation

D/A Converters (2 or 4)

Type: Texas Instruments DAC5688

Input Data Rate: 250 MHz max.

Output IF: DC to 400 MHz max.

Output Signal: 2-channel real or
1-channel with frequency translation

Output Sampling Rate: 800 MHz max.
with 2x, 4x or 8x interpolation

Resolution: 16 bits

Digital Interpolators (1 or 2)

Interpolation Range: 2x to 65,536x in
two stages of 2x to 256x

Beamformers (1 or 2)

Summation: Three channels on-board;
multiple boards can be summed via
Summation Expansion Chain

Summation Expansion Chain: One
chain in and one chain out link via J3
connector using Aurora protocol;
via J3 and J5 for Model 74621

Phase Shift Coefficients: I & Q with
16-bit resolution

Gain Coefficients: 16-bit resolution

Channel Summation: 24-bit

Multiboard Summation Expansion:
32-bit

Front Panel Analog Signal Outputs (2 or 4)

Output: Transformer-coupled, front
panel female SSMC connectors

Transformer: Coil Craft WBC4-6TLB

Full Scale Output: +4 dBm into 50 ohms
3 dB Passband: 300 kHz to 700 MHz

Sample Clock Sources (2 or 4)

On-board clock synthesizer generates
two clocks: one A/D clock and one
D/A clock

Clock Synthesizers (1 or 2)

Clock Source: Selectable from on-board
programmable VCXO (10 to 810 MHz),
front panel external clock or LVPECL
timing bus

Synchronization: VCXO can be locked
to an external 4 to 180 MHz PLL system
reference, typically 10 MHz

Clock Dividers: External clock or VCXO
can be divided by 1, 2, 4, 8, or 16, inde-
pendently for the A/D clock and D/A
clock

External Clocks (1 or 2)

Type: Front panel female SSMC connector,
sine wave, 0 to +10 dBm, AC-coupled,
50 ohms, accepts 10 to 800 MHz divider
input clock or PLL system reference

Timing Bus (1 or 2): 26-pin connector
LVPECL bus includes, clock/sync/gate/
PPS inputs and outputs; TTL signal for
gate/trigger and sync/PPS inputs

Field Programmable Gate Arrays (1 or 2)

Standard: Xilinx Virtex-6 XC6VLX240T

Optional: Xilinx Virtex-6 XC6VVSX315T

Memory Banks (1 or 2)

Option 150 or 160: Two 8 MB QDRII+
SRAM memory banks, 400 MHz DDR
Option 155 or 165: Two 512 MB DDR3
SDRAM memory banks, 400 MHz DDR

PCI-X Interface

PCI-X Bus: 32 or 64 bits at 33 or 66 MHz
Model 73621: 32 bits only

Environmental

Operating Temp: 0° to 50° C

Storage Temp: -20° to 90° C

Relative Humidity: 0 to 95%, non-cond.

Size: Standard 6U or 3U cPCI board

Ordering Information

| Model | Description |
|-------|--|
| 72621 | 3-Channel 200 MHz A/D with DDC, DUC with 2-Channel 800 MHz D/A, and a Virtex-6 FPGA - 6U cPCI |
| 73621 | 3-Channel 200 MHz A/D with DDC, DUC with 2-Channel 800 MHz D/A, and a Virtex-6 FPGA - 3U cPCI |
| 74621 | 6-Channel 200 MHz A/D with DDCs, DUCs with 4-Channel 800 MHz D/A, and two Virtex-6 FPGAs - 6U cPCI |

Options:

| | |
|------|--|
| -062 | XC6VLX240T |
| -064 | XC6VVSX315T |
| -150 | Two 8 MB QDRII+ SRAM Memory Banks (Banks 1 and 2) |
| -160 | Two 8 MB QDRII+ SRAM Memory Banks (Banks 3 and 4) |
| -155 | Two 512 MB DDR3 SDRAM Memory Banks (Banks 1 and 2) |
| -165 | Two 512 MB DDR3 SDRAM Memory Banks (Banks 3 and 4) |

A/D Performance

Spurious Free Dynamic Range

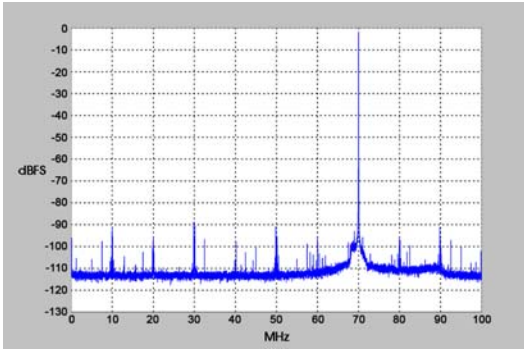

$f_{in} = 70 \text{ MHz}$, $f_s = 200 \text{ MHz}$, Internal Clock

Spurious Pick-up

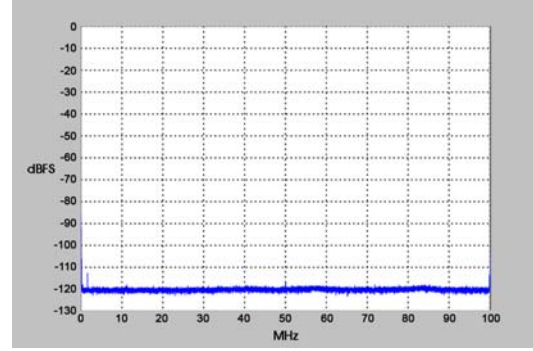

$f_s = 200 \text{ MHz}$, Internal Clock

Two-Tone SFDR

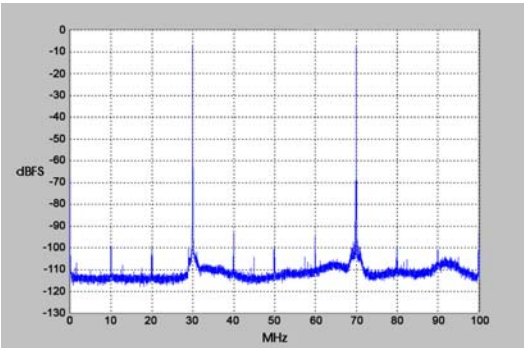

$f_1 = 30 \text{ MHz}$, $f_2 = 70 \text{ MHz}$, $f_s = 200 \text{ MHz}$

Two-Tone SFDR

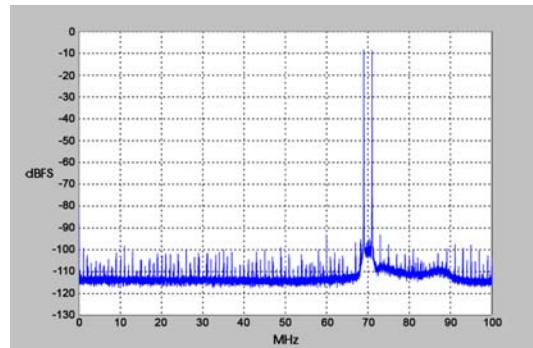

$f_1 = 69 \text{ MHz}$, $f_2 = 71 \text{ MHz}$, $f_s = 200 \text{ MHz}$

Adjacent Channel Crosstalk

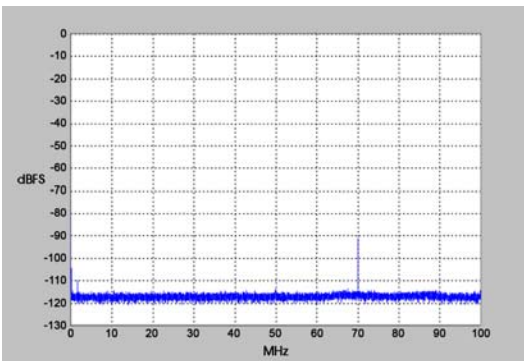

$f_{in \text{ Ch2}} = 70 \text{ MHz}$, $f_s = 200 \text{ MHz}$, Ch 1 shown

Input Frequency Response

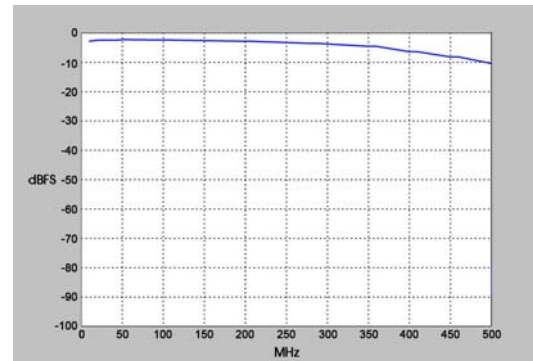

$f_s = 200 \text{ MHz}$, Internal Clock

Spurious Free Dynamic Range

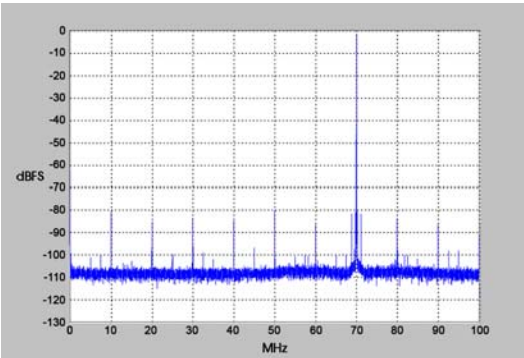

$f_{out} = 70 \text{ MHz}$, $f_s = 200 \text{ MHz}$, Internal Clock

D/A Performance

Spurious Free Dynamic Range

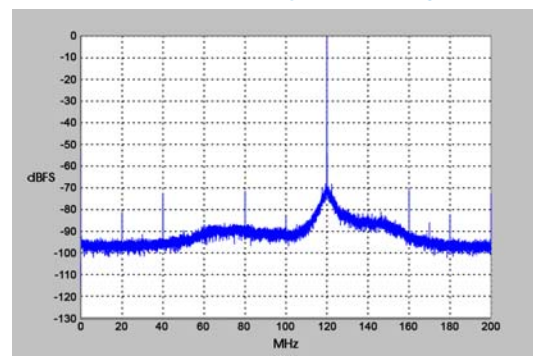

$f_{out} = 140 \text{ MHz}$, $f_s = 400 \text{ MHz}$, External Clock