



Model 7341 Model 7241D



Features

- Two or four 125 MHz 14-bit A/Ds
- Input signal bandwidth up to 50 MHz
- Four or eight digital downconverters
- One or two digital upconverters
- Two or four 500 MHz 16-bit D/As
- 512 or 1024 MB DDR SDRAM
- One or two Xilinx Virtex-II Pro FPGAs
- Up to 1.28 seconds delay or data capture at 100 MHz
- Dual timing buses for independent input and output clock rates
- LVDS clock/sync bus for multi-module synchronization
- 32 or 64 pairs of LVDS connections to the Virtex-II Pro FPGA for custom I/O
- Optional factory-installed IP Cores available

General Information

Models 7241 and 7341 are cPCI multiband transceivers. They consist of one Model 7141 transceiver mounted on a cPCI carrier. The Model 7241 is a 6U cPCI board, while the Model 7341 is a 3U cPCI board. Model 7241D is the same as the Model 7241, except it contains two 7141's rather than one.

A/D Converter Stage

The front end accepts full scale analog HF or IF inputs on front panel MMX connectors at +10 dBm into 50 ohms with transformer coupling into LTC2255 14-bit 125 MHz A/D converters.

The digital outputs are delivered into the Virtex-II Pro FPGAs for signal processing or for routing to other board resources.

Digital Downconverter Stages

The TI/Graychip GC4016 quad digital downconverters accept either four 14-bit inputs or three 16-bit digital inputs from the FPGAs, which determine the source of GC4016 input data. These sources include the A/D converters, FPGA signal processing engines, SDRAM delay memory and data sources on the cPCI bus.

Each GC4016 channel may be set for independent tuning frequency and bandwidth. For an A/D sample clock frequency of 100 MHz, the output bandwidth for each channel ranges from 5 kHz up to 2.5 MHz. By combining two or four channels, output bandwidth of up to 5 or 10 MHz can be achieved.

Digital Upconverter Stages

The TI DAC5686 digital upconverters (DUC) and dual D/As accept baseband real

or complex data streams from the FPGAs with signal bandwidths up to 40 MHz.

When operating as upconverters, they interpolate and translate real or complex baseband input signals to any IF center frequency between DC and 160 MHz. They deliver real or quadrature (I+Q) analog outputs through two 320 MHz 16-bit D/A converters to front panel MMCX connectors at +4 dBm into 50 ohms.

If translation is disabled, the DAC5686 acts as a two channel interpolating 16-bit D/A with output sampling rates up to 500 MHz.

Virtex-II Pro FPGAs

The Xilinx XC2VP50 Virtex-II Pro FPGAs serve as a control and status engines with data and programming interfaces to each of the on-board resources including the A/D converters, GC4016 digital downconverters, digital upconverters and D/A converters.

Factory installed FPGA functions include data multiplexing, channel selection, data packing, gating, triggering and SDRAM memory control.

Option -104 adds 32 pairs of LVDS connections to the Virtex-II Pro FPGA for custom I/O through the cPCI J3 connector. With Model 7241D, the option provides an additional 32 pairs through J5 to the second FPGA.

Each FPGA includes two PowerPC cores which can be used as local microcontrollers to create complete application engines.

Clocking and Synchronization

Two independent internal timing buses can provide either a single clock or two different clock rates for the input and output signals. ➤

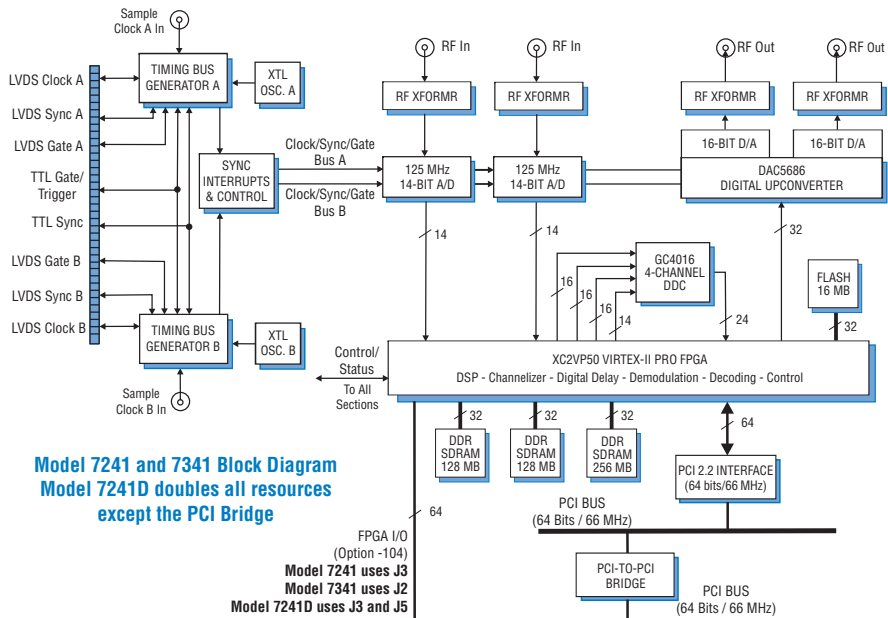

Model 7241 and 7341 Block Diagram
Model 7241D doubles all resources
except the PCI Bridge

FPGA I/O
(Option -104)
Model 7241 uses J3
Model 7341 uses J2
Model 7241D uses J3 and J5

► Each timing bus includes a clock, a sync, and a gate or trigger signal. Signals from either Timing Bus A or B can be selected as the timing source for the A/Ds, the downconverters, the upconverters and the D/As. Two external reference clocks are accepted, one for each timing bus and two internal clocks may be used for each timing bus.

Front panel 26-pin LVDS Clock/Sync connectors allow multiple boards to be synchronized. In the slave mode, they accept differential LVDS inputs that drive the clock, sync and gate signals for the two internal timing buses.

In the master mode, the LVDS bus can drive one or both sets of timing signals from the two internal timing buses for synchronizing multiple modules.

Up to four slave 7241D's or seven 7341's can be driven from the LVDS bus master, supporting synchronous sampling and sync functions across all connected boards. Up to eighty 7241 or 7341 boards, or forty 7241D boards may be synchronized with a Model 9190 Clock and Sync Generator.

Memory Resources

Three independent banks of SDRAM are available to each FPGA. Built-in memory functions include an A/D data transient capture mode with pre- and post-triggering; a D/A waveform generator mode; and an A/D data delay mode for applications like tracking receivers. User-installed functions within the FPGA can take advantage of the SDRAM for many other purposes.

The SDRAMs are also available as a resource for the two PowerPC processor cores within each FPGA. Dual 16 MB FLASH memories support booting and program store for these processors.

PCI Interface

These models include an industry-standard interface fully compliant with PCI 2.2 bus specifications. The interface includes nine separate DMA controllers for efficient transfers to and from the module. Data widths of 32 or 64 bits and data rates of 33 or 66 MHz are supported.

Specifications

7241: Dual Configuration

7241D: Quad Configuration

7341: Dual Configuration

7241D shown in the Specifications

Front Panel Analog Signal Inputs (4)

Input Type: Transformer-coupled, front panel female MMCX connectors

Transformer Type: Coil Craft WBC1-1TLB

Full Scale Input: +10 dBm into 50 ohms

3 dB Passband: 250 kHz to 300 MHz

A/D Converters (4)

Type: Linear Technology LTC2255

Sampling Rate: 1 MHz to 125 MHz

Internal Clock: Crystal oscillator A or B

External Clock: 1 to 125 MHz

Resolution: 14 bits

Digital Downconverters (2)

Type: TI/Graychip GC4016

Decimation: 32 to 16,384; with channel combining mode: 8 or 16

Data Source: A/D, FPGA, or PCI interface

Control Source: FPGA or PCI interface

Output: Parallel complex data

Receiver Bypass Mode: Data from the A/Ds can be written directly into the FPGAs at a rate equal to the A/D clock decimated by any integer between 1 and 4096

Front Panel Analog Signal Outputs (4)

Output Type: Transformer-coupled, front panel female MMCX connectors

Full Scale Output: +4 dBm into 50 ohms

Option -002: -2 dBm into 50 ohms

3 dB Passband: 60 kHz to 300 MHz

Option -002: 400 kHz to 800 MHz

Digital Upconverters (2)

Type: TI DAC5686

Input Bandwidth: 40 MHz, max.

Output IF: DC to 160 MHz

Output Signal: Analog, real or quadrature
Sampling Rate: 320 MHz, max; 500 MHz max. with upconversion disabled

Resolution: 16 bits

Clock Sources (4): Selectable from onboard A or B crystal oscillators, external or LVDS clocks

External Clocks (4)

Type: Front panel female MMCX connector, sine wave, 0 to +10 dBm, AC-coupled, 50 ohms

Sync/Gate Bus (2): 26-pin connector, dual clock/sync/gate input/output LVDS buses; one sync/gate input TTL signal

Field Programmable Gate Array (2)

Type: Xilinx Virtex-II Pro

Option -050: XC2VP50

Option -104: Installs J3 and J5 connectors with 64 lines to each XC2VP50 FPGA

Memory

DDR SDRAM: 1 GB in six banks

FLASH: 32 MB in two banks

PCI Interface

PCI Bus: 64-bit, 66 MHz (also supports 32-bit and/or 33 MHz)

Local Bus: 64-bit, 66 MHz

DMA: 9 channel demand-mode and chaining controller

Environmental

Operating Temp: 0° to 50° C

Storage Temp: -20° to 90° C

Relative Humidity: 0 to 95%, non-cond.

Size: Standard 6U cPCI board

Ordering Information

Model	Description
7241	Dual Multiband Transceiver with FPGA - 6U cPCI
7241D	Quad Multiband Transceiver with FPGAs - 6U cPCI
7341	Dual Multiband Transceiver with FPGA - 3U cPCI
Options:	
-002	Full-Scale Output: -2 dBm into 50 ohms; 3 dB Passband: 400 kHz to 800 MHz
-050	XC2VP50 Virtex-II Pro FPGA
-100	100 MHz Bus A and Bus B oscillators
-101	TI DAC5687 replaces the TI DAC5686
-104	FPGA I/O through J3 for 7241; J2 for 7341; J3 and J5 for 7241D
-125	125 MHz Bus A and 100 MHz Bus B internal oscillators
-420	GateFlow Installed core: Dual wideband DDC and interpolation filter
-430	GateFlow Installed core: 256-channel narrowband DDC

A/D Performance

Spurious Free Dynamic Range

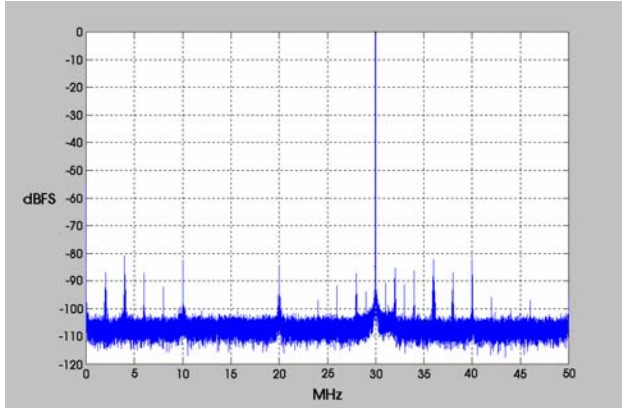

$f_{in} = 70 \text{ MHz}, f_s = 100 \text{ MHz}$

Spurious Pick-up

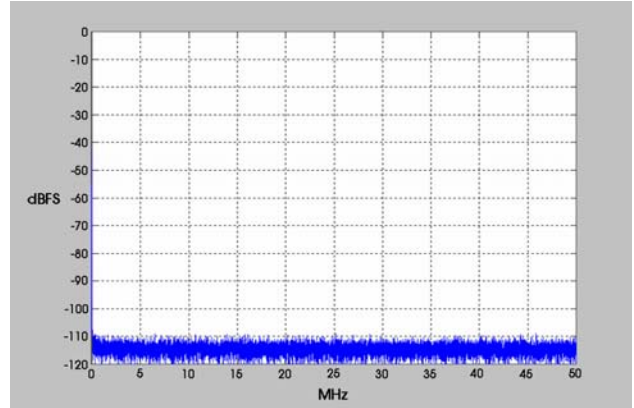

$f_s = 100 \text{ MHz}, 32k \text{ point FFT}, 8 \text{ averages}$

Input Frequency Response

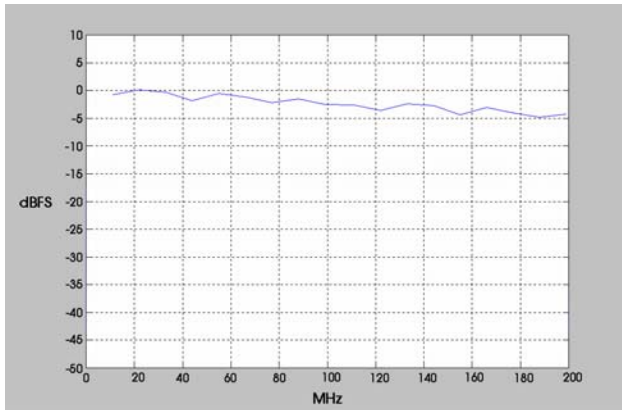

$f_s = 100 \text{ MHz}$

Two Tone SFDR

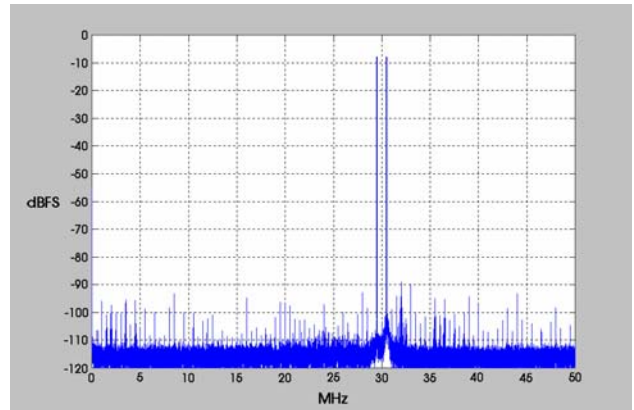

$f_1 = 29.5 \text{ MHz}, f_2 = 30.5 \text{ MHz}, f_s = 100 \text{ MHz}$

Crosstalk

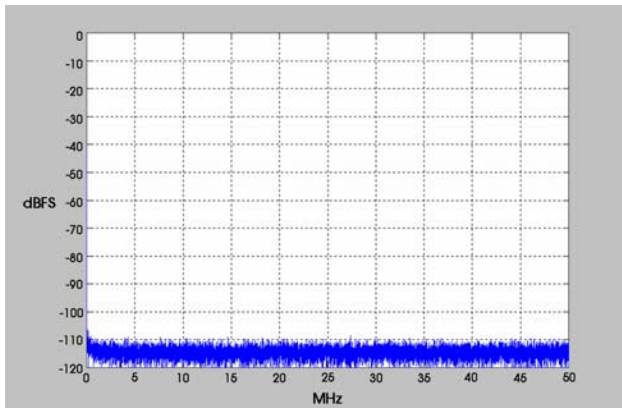

$f_{in \text{ Ch2}} = 69 \text{ MHz}, f_s = 100 \text{ MHz}, \text{ Ch 1 shown}$

Phase Noise

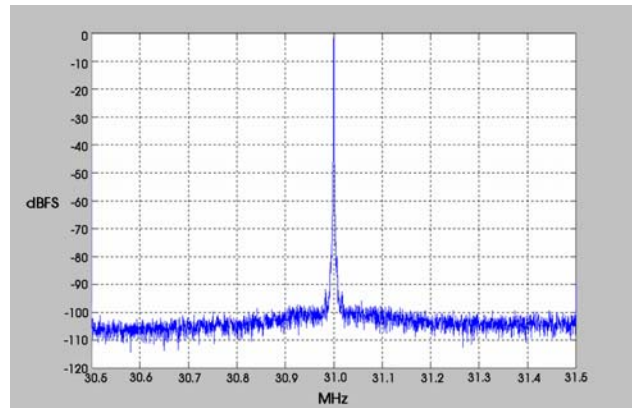

$f_{in} = 69 \text{ MHz}, f_s = 100 \text{ MHz}$
Phase Noise @ 100 kHz = $-102 - 10 \cdot \log(610) = -129.8 \text{ dB/Hz}$

D/A Performance

Two Tone Intermodulation Distortion

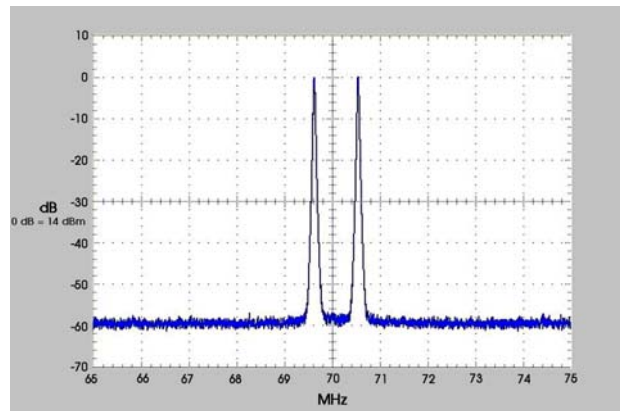

$f_1 = 69.5 \text{ MHz}$, $f_2 = 70.5 \text{ MHz}$, $f_s = 100 \text{ MHz}$