

New!

Models 57721 & 58721

3- or 6-Channel 200 MHz A/D with DDC, DUC with 2- or 4-Channel 800 MHz D/A, Virtex-7 FPGAs - 6U OpenVPX



Model 58721



Features

- Supports Xilinx Virtex-7 VXT FPGAs
- GateXpress supports dynamic FPGA reconfiguration across PCIe
- Three or six 200 MHz 16-bit A/Ds
- Three or six multiband DDCs
- One or two DUCs
- Two or four 800 MHz 16-bit D/As
- Multiband programmable beamformer
- 4 or 8 GB of DDR3 SDRAM
- PCI Express (Gen. 1, 2 & 3) interface up to x8
- Optional LVDS connections to the Virtex-7 FPGA for custom I/O
- Ruggedized and conduction-cooled versions available

General Information

Models 57721 and 58721 are members of the Onyx® family of high-performance 6U OpenVPX boards based on the Xilinx Virtex-7 FPGA. They consist of one or two Model 71721 XMC modules mounted on a VPX carrier board.

Model 57721 is a 6U board with one Model 71721 module while the Model 58721 is a 6U board with two XMC modules rather than one.

These models include three or six A/Ds, programmable DDCs, one or two DUCs, two or four D/As and four or eight banks of memory.

The Onyx Architecture

Based on the proven design of the Pentek Cobalt family, Onyx raises the processing performance with the new flagship family of Virtex-7 FPGAs from Xilinx. As the central feature of the board architecture, the FPGA has access to all data and control paths, enabling factory-installed functions including data multiplexing, channel selection, data packing, gating, triggering and memory control. The Onyx Architecture organizes the FPGA as a container for data processing applications where each function exists as an intellectual property (IP) module.

Each member of the Onyx family is delivered with factory-installed applications ideally matched to the board's analog interfaces. The factory-installed functions in these models include three or six A/D acquisition and one or two D/A waveform playback IP modules. Each of the acquisition IP modules contains a powerful programmable DDC IP core. The waveform playback IP module

contains one or two interpolation IP cores, ideal for matching playback rates to the data and decimation rates of the acquisition modules. IP modules for DDR3 SDRAM memories, controllers for all data clocking and synchronization functions, one or two test signal generators, one or two programmable beamforming IP cores, and one or two Aurora gigabit serial interfaces complete the factory-installed functions and enable these models to operate as complete turnkey solutions, without the need to develop FPGA IP.

Extendable IP Design

For applications that require specialized function, users can install their own custom IP for data processing. Pentek GateFlow FPGA Design Kits include all of the factory-installed modules as documented source code. Developers can integrate their own IP with the Pentek factory-installed functions or use the GateFlow kit to completely replace the Pentek IP with their own.

Xilinx Virtex-7 FPGA

The Virtex-7 FPGA site can be populated with one of two FPGAs to match the specific requirements of the processing task. Supported FPGAs are VX330T or VX690T. The VX690T features 3600 DSP48E1 slices and is ideal for modulation/demodulation, encoding/decoding, encryption/decryption, and channelization of the signals between transmission and reception. For applications not requiring large DSP resources or logic, the lower-cost VX330T can be installed.

Option -104 provides 24 LVDS pairs between the FPGA and the VPX P3 connector, Model 57721; P3 and P5, Model 58721. ▶

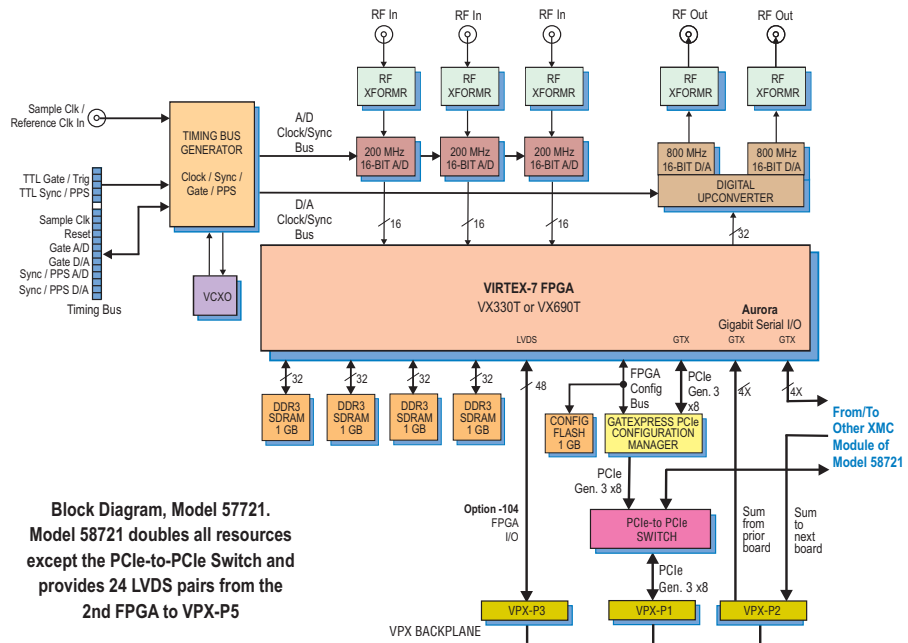

A/D Acquisition IP Modules

These models feature three or six A/D Acquisition IP Modules for easily capturing and moving data. Each module can receive data from any of the three A/Ds, a test signal generator or from the D/A Waveform Playback IP Module in loopback mode.

Each IP module has an associated memory bank for buffering data in FIFO mode or for storing data in transient capture mode. All memory banks are supported with DMA engines for easily moving A/D data through the PCIe interface.

These powerful linked-list DMA engines are capable of a unique Acquisition Gate Driven mode. In this mode, the length of a transfer performed by a link definition need not be known prior to data acquisition; rather, it is governed by the length of the acquisition gate. This is extremely useful in applications where an external gate drives acquisition and the exact length of that gate is not known or is likely to vary.

For each transfer, the DMA engine can automatically construct metadata packets containing A/D channel ID, a sample-accurate time stamp and data length information. These actions simplify the host processor's job of identifying and executing on the data.

DDC IP Cores

Within each A/D Acquisition IP Module is a powerful DDC IP core. Because of the flexible input routing of the A/D Acquisition IP Modules, many different configurations can be achieved including one A/D driving all three DDCs or each of the three A/Ds driving its own DDC.

Each DDC has an independent 32-bit tuning frequency setting that ranges from DC to

f_s , where f_s is the A/D sampling frequency. Each DDC can have its own unique decimation setting, supporting as many as three different output bandwidths for the board. Decimations can be programmed from 2 to 65,536 providing a wide range to satisfy most applications.

The decimating filter for each DDC accepts a unique set of user-supplied 18-bit coefficients. The 80% default filters deliver an output bandwidth of $0.8 * f_s / N$, where N is the decimation setting. The rejection of adjacent-band components within the 80% output bandwidth is better than 100 dB. Each DDC delivers a complex output stream consisting of 24-bit I + 24-bit Q or 16-bit I + 16-bit Q samples at a rate of f_s / N .

Beamformer IP Cores

In addition to the DDCs, these models feature one or two beamforming subsystems. Each DDC core contains programable I & Q phase and gain adjustments followed by a power meter that continuously measures the individual average power output. The time constant of the averaging interval for each meter is programmable up to 8K samples. The power meters present average power measurements for each DDC core output in easy-to-read registers.

In addition, each DDC core includes a threshold detector to automatically send an interrupt to the processor if the average

power level of any DDC core falls below or exceeds a programmable threshold.

A programmable summation block provides summing of any of the three DDC core outputs. An additional programmable gain stage compensates for summation change bit growth. A power meter and threshold detect block is provided for the summed output. The output is then directed back into the A/D Acquisition IP Module 1 FIFO for reading over the PCIe. For larger systems, multiple boards can be chained together via a built-in Xilinx Aurora gigabit serial interface. This allows summation across channels on multiple boards.

D/A Waveform Playback IP Module

The factory-installed functions in these models include one or two sophisticated D/A Waveform Playback IP modules. A linked-list controller allows users to easily play back to the dual D/As waveforms stored in either on-board memory or off-board host memory.

Parameters including length of waveform, delay from playback trigger, waveform repetition, etc. can be programmed for each waveform.

Up to 64 or 128 individual link entries can be chained together to create complex waveforms with a minimum of programming. ➤

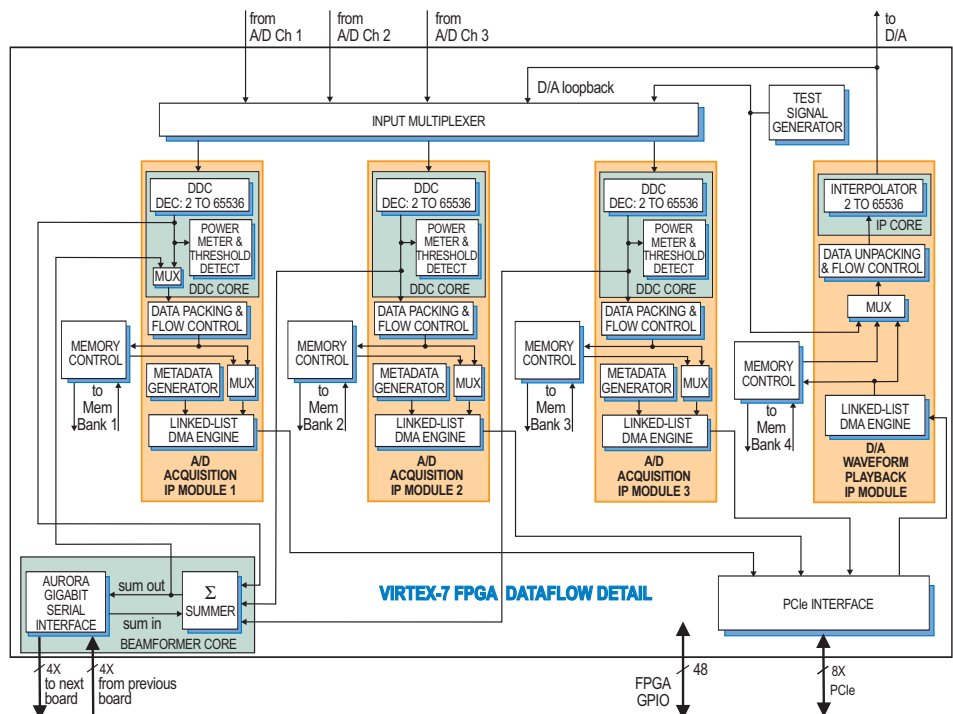

► GateXpress for FPGA Configuration

The Onyx architecture includes GateXpress, a sophisticated FPGA-PCIe configuration manager for loading and reloading the FPGAs. At power-up, GateXpress immediately presents a target for the host computer to discover, effectively giving the FPGAs time to load from FLASH. This is especially important for larger FPGAs where the loading times can exceed the PCIe discovery window, typically 100 msec on most PCs.

The board's configuration FLASH can hold four FPGA images. Images can be factory-installed IP or custom IP created by the user. In this case, it's programmed into the FLASH via JTAG using Xilinx iMPACT or through the board's PCIe interface. At power-up the user can choose which image to load based on a hardware switch setting.

Once booted, GateXpress allows the user three options for dynamically reconfiguring the FPGAs with new IP images. The first option is to load an alternate image from FLASH through software control. The user selects the desired image and issues a reload command.

The second option is for applications where the FPGA image must be loaded directly through the PCIe interface. This is important in security situations where there can be no latent user image left in nonvolatile memory when power is removed. In applications where the FPGA IP may need to change many times during the course of a mission, images can be stored on the host computer and loaded as needed.

The third option, typically used during development, allows the user to directly load the FPGAs through JTAG using Xilinx iMPACT.

In all three FPGA-loading scenarios, GateXpress handles the hardware negotiation thereby simplifying and streamlining the loading task. In addition, GateXpress preserves the PCIe configuration space allowing dynamic FPGA reconfiguration without the need to reset the host computer so it can rediscover the board. After the reload, the host computer simply continues to see the board with the expected device ID.

A/D Converter Stage

The front end accepts three or six analog HF or IF inputs on front panel SSMC connectors with transformer coupling into Texas Instruments ADS5485 200 MHz, 16-bit A/D converters.

The digital outputs are delivered into the Virtex-7 FPGAs for signal processing, data capture and for routing to other board resources.

Digital Upconverter and D/A Stage

One or two TI DAC5688 DUC (digital upconverters) and D/As accept baseband real or complex data stream from the FPGAs and provide that input to the upconvert, interpolate and dual D/A stages.

When operating as a DUC, it interpolates and translates real or complex baseband input signals to any IF center frequency up to 360 MHz. It delivers real or quadrature (I+Q) analog outputs to the dual 16-bit D/A converter. Analog output is through a pair of front panel SSMC connectors.

If translation is disabled, the DAC5688 acts as a dual interpolating 16-bit D/A with output sampling rates up to 800 MHz. In both modes the DAC5688 provides interpolation factors of 2x, 4x and 8x. In addition to the DAC5688, an FPGA-based interpolator core provides additional interpolation from 2x to 65,536x. The two interpolators can be combined to create a total range from 2x to 524,288x.

Clocking and Synchronization

Two internal timing buses provide either a single clock or two different clock rates to the A/D and D/A signal paths.

Each timing bus includes a clock, sync and a gate or trigger signal. An on-board clock generator receives an external sample clock from the front panel SSMC connector. This clock can be used directly for either the A/D or D/A sections or can be divided by a built-in clock synthesizer circuit to provide different A/D and D/A clocks. In an alternate mode, the sample clock can be sourced from an on-board programmable VCXO (Voltage-Controlled Crystal Oscillator). In this mode, the front panel SSMC connector can be used to provide a 10 MHz reference clock for synchronizing the internal oscillator.

A front panel 26-pin LVPECL Clock/Sync connector allows multiple boards to be synchronized. In the slave mode, it accepts LVPECL inputs that drive the clock, sync and gate signals. In the master mode, the LVPECL bus can drive the timing signals for synchronizing multiple boards.

Multiple boards can be driven from the LVPECL bus master, supporting synchronous sampling and sync functions across all connected boards.

PCI Express Interface

These models include an industry-standard interface fully compliant with PCI Express Gen. 1, 2 and 3 bus specifications. Supporting PCIe links up to x8, the interface includes multiple DMA controllers for efficient transfers to and from the board. ►

► **Memory Resources**

The architecture supports four or eight independent DDR3 SDRAM memory banks.

Each bank is 1 GB deep and is an integral part of the board's DMA capabilities, providing FIFO memory space for creating DMA packets. Built-in memory functions include an A/D data transient capture mode and D/A waveform playback mode.

In addition to the factory-installed functions, custom user-installed IP within the FPGA can take advantage of the memories for many other purposes.

Specifications

Model 57721: 3 A/Ds, 1 DUC, 2 D/As

Model 58721: 6 A/Ds, 2 DUCs, 4 D/As

Front Panel Analog Signal Inputs (3 or 6)

Input: Transformer-coupled, front panel female SSMC connectors

Transformer: Coil Craft WBC4-6TLB

Full Scale Input: +8 dBm into 50 ohms

3 dB Passband: 300 kHz to 700 MHz

A/D Converters (3 or 6)

Type: Texas Instruments ADS5485

Sampling Rate: 10 MHz to 200 MHz

Resolution: 16 bits

Digital Downconverters (3 or 6)

Decimation Range: 2x to 65,536x in two stages of 2x to 256x

LO Tuning Freq. Resolution: 32 bits, 0 to f_s

LO SFDR: >120 dB

Phase Offset Resolution: 32 bits, 0 to 360 degrees

FIR Filter: 18-bit coefficients, 24-bit output, with user programmable coefficients

Default Filter Set: 80% bandwidth, <0.3 dB passband ripple, >100 dB stopband attenuation

D/A Converters (2 or 4)

Type: Texas Instruments DAC5688

Input Data Rate: 250 MHz max.

Output IF: DC to 400 MHz max.

Output Signal: 2-channel real or 1-channel with frequency translation

Output Sampling Rate: 800 MHz max. with 2x, 4x or 8x interpolation

Resolution: 16 bits

Digital Interpolators (1 or 2)

Interpolation Range: 2x to 65,536x in two stages of 2x to 256x

Beamformers (1 or 2)

Summation: Three channels on-board; multiple boards can be summed via Summation Expansion Chain

Summation Expansion Chain: One chain in and one chain out link via VPX P2 connector using Aurora protocol

Phase Shift Coefficients: I & Q with 16-bit resolution

Gain Coefficients: 16-bit resolution

Channel Summation: 24-bit

Multiboard Summation Expansion: 32-bit

Front Panel Analog Signal Outputs (2 or 4)

Output: Transformer-coupled, front panel female SSMC connectors

Transformer: Coil Craft WBC4-6TLB

Full Scale Output: +4 dBm into 50 ohms

3 dB Passband: 300 kHz to 700 MHz

Sample Clock Sources (2 or 4)

On-board clock synthesizer generates two clocks: one A/D clock and one D/A clock

Clock Synthesizers (1 or 2)

Clock Source: Selectable from on-board programmable VCXO (10 to 810 MHz), front panel external clock or LVPECL timing bus

Synchronization: VCXO can be locked to an external 4 to 180 MHz PLL system reference, typically 10 MHz

Clock Dividers: External clock or VCXO can be divided by 1, 2, 4, 8, or 16, independently for the A/D clock and D/A clock

External Clocks (1 or 2)

Type: Front panel female SSMC connector, sine wave, 0 to +10 dBm, AC-coupled, 50 ohms, accepts 10 to 800 MHz divider input clock or PLL system reference

Timing Bus (1 or 2): 26-pin connector LVPECL bus includes, clock/sync/gate/PPS inputs and outputs; TTL signal for gate/trigger and sync/PPS inputs

Field Programmable Gate Arrays (1 or 2)

Standard: Xilinx Virtex-7 XC7VX330T-2

Optional: Xilinx Virtex-7 XC7VX690T-2

Custom I/O

Option -104: Provides 24 LVDS pairs between the FPGA and the VPX P3 connector, Model 57721; P3 and P5, connectors, Model 58721

Memory Banks (4 or 8)

Type: DDR3 SDRAM

Size: 1 GB each

Speed: 800 MHz (1600 MHz DDR)

PCI-Express Interface

PCI Express Bus: Gen. 1, 2 or 3: x4 or x8

Environmental: Level L1 & L2 air-cooled;

Level L3 ruggedized, conduction-cooled

Size: 3.937 in. x 6.717 in. (100 mm x 170.6 mm)

Ordering Information

Model	Description
57721	3-Channel 200 MHz A/D with DDC, DUC with 2-Channel 800 MHz D/A, and a Virtex-7 FPGA - 6U VPX
58721	6-Channel 200 MHz A/D with DDCs, DUCs with 4-Channel 800 MHz D/A, and two Virtex-7 FPGAs - 6U VPX

Options:

-076	XC7VX690T-2 FPGA
-104	LVDS I/O between the FPGA and P3 connector, Model 57721; P3 and P5 connectors, Model 58721

Contact Pentek for availability of rugged and conduction-cooled versions



A/D Performance

Spurious Free Dynamic Range

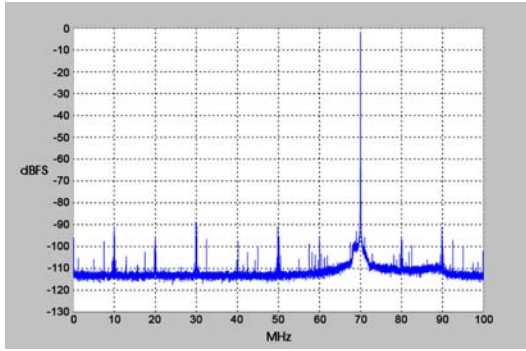

$f_{in} = 70 \text{ MHz}, f_s = 200 \text{ MHz}, \text{Internal Clock}$

Spurious Pick-up

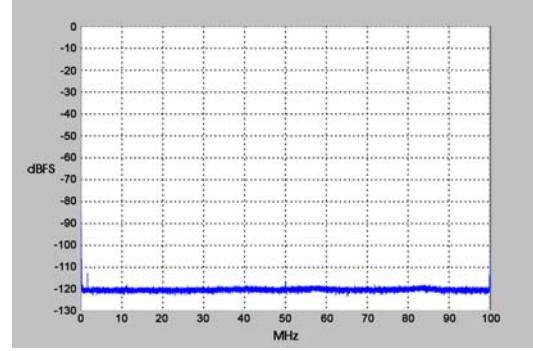

$f_s = 200 \text{ MHz}, \text{Internal Clock}$

Two-Tone SFDR

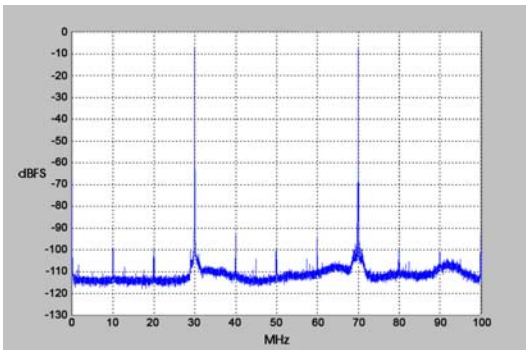

$f_1 = 30 \text{ MHz}, f_2 = 70 \text{ MHz}, f_s = 200 \text{ MHz}$

Two-Tone SFDR

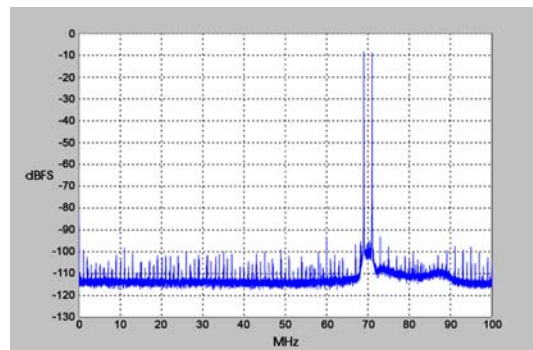

$f_1 = 69 \text{ MHz}, f_2 = 71 \text{ MHz}, f_s = 200 \text{ MHz}$

Adjacent Channel Crosstalk

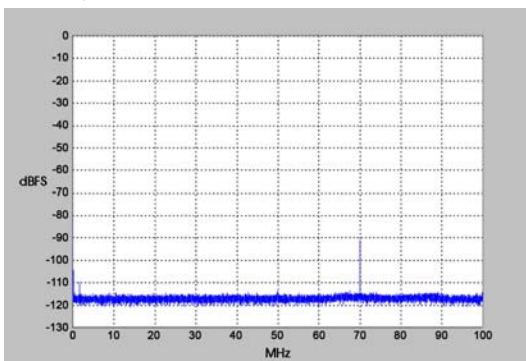

$f_{in \text{ Ch2}} = 70 \text{ MHz}, f_s = 200 \text{ MHz}, \text{Ch 1 shown}$

Input Frequency Response

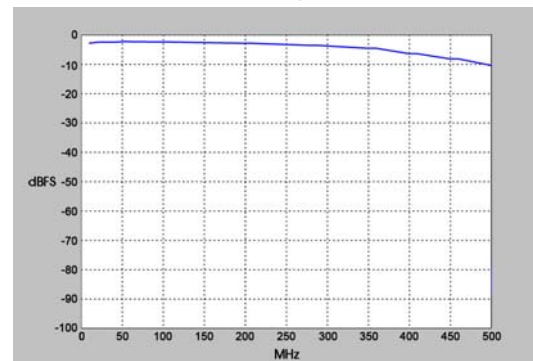

$f_s = 200 \text{ MHz}, \text{Internal Clock}$

Spurious Free Dynamic Range

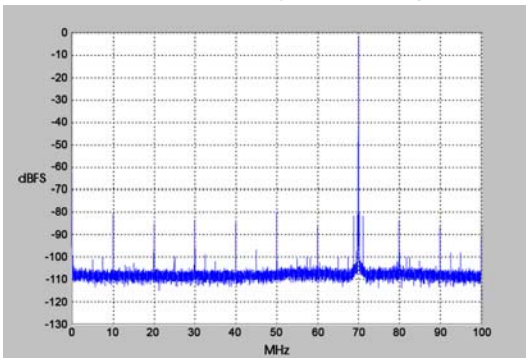

$f_{out} = 70 \text{ MHz}, f_s = 200 \text{ MHz}, \text{Internal Clock}$

D/A Performance

Spurious Free Dynamic Range

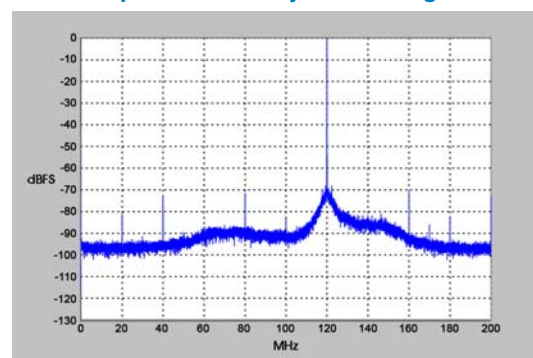

$f_{out} = 140 \text{ MHz}, f_s = 400 \text{ MHz}, \text{External Clock}$