

New!

Model RTS 2701

2-Channel RF/IF 125 MS/sec Rack-mount Recorder



Features

- Dual channel multiband recording and playback system
- 19 inch industrial rack-mount PC server chassis
- Complete high performance Windows® workstation
- Two 14-bit 125 MHz A/Ds
- One 16-bit 500 MHz D/A
- Real-time sustained recording rates of up to 480 MB/sec
- 4 terabytes of storage to NTFS RAID disk array
- RAID levels 0, 1, 5, 6, 10 and 50
- Windows SystemFlow® Record/Playback software
- Complete GUI with Signal Viewer analysis tool which includes a virtual oscilloscope and spectrum analyzer
- File headers include time stamping and recording parameters
- DDC decimation and DUC interpolation ranges from 2 to 32,768
- 8 kHz to 60 MHz baseband record and playback signal bandwidths
- IF frequencies to 300 MHz
- Ideal for communications, radar, wireless, SIGINT, telecom and satcom
- Optional GPS time and position stamping

Contact factory for options, for number and type of analog channels, recording rates, and disk capacity.

General Information

The Talon™ RTS 2701 is a turnkey, multi-band recording and playback system that allows the user to record and reproduce high-bandwidth signals. The RTS 2701 provides sustained recording rates of up to 480 MB/sec in a dual-channel configuration and is ideal for the user that requires a powerful rack-mount recording system.

The heart of the RTS 2701 is the Pentek Model 7641-420 multiband transceiver, which includes A/D and D/A converters, digital upconverters (DUCs), digital downconverters (DDCs), and an FPGA-installed IP core. The architecture allows the system engineer to take full advantage of modern technology in a turnkey system.

Optional GPS time and position stamping allows the user to record this critical signal information.

SystemFlow Software

Included with this system is Pentek's SystemFlow Recording Software. A software API is provided that allows users to integrate control of the RTS instrument into their system.

The RTS 2701 features a Windows-based GUI (Graphical User Interface) that provides a simple means to configure and control the system. Custom configurations can be stored as profiles and later loaded when needed, allowing the user to select preconfigured settings with a single click.

SystemFlow also includes signal viewing and analysis tools, that allow the user to monitor the signal prior to, during and after a recording session. These tools include a virtual oscilloscope and a virtual spectrum analyzer.

Built on a Windows XP Professional workstation, the RTS 2701 allows the user to install post processing and analysis tools to operate on the recorded data. The RTS 2701 records data to the native NTFS file system, providing immediate access to the recorded data. Data can be offloaded via gigabit Ethernet, or USB 2.0 ports. Additionally, data can be copied to disk, using the 8X double layer DVD±R/RW drive.

Flexible Architecture

Pentek's multiband recorder system provides a flexible architecture that is easily customized to meet the user's needs. Multiple RAID levels, including 0, 1, 5, 6, 10 and 50, provide a choice for the required level of redundancy. Total drive capacity is 4 TB using 10 drives.

The system supports simultaneous recording of one or two wideband A/D or multiband DDC channels. The analog output allows a single recorded signal to be reproduced as either a baseband or an upconverted IF signal. With its range of programmable decimation and interpolation factors, the system supports signal bandwidths from 8 kHz to 60 MHz. ➤

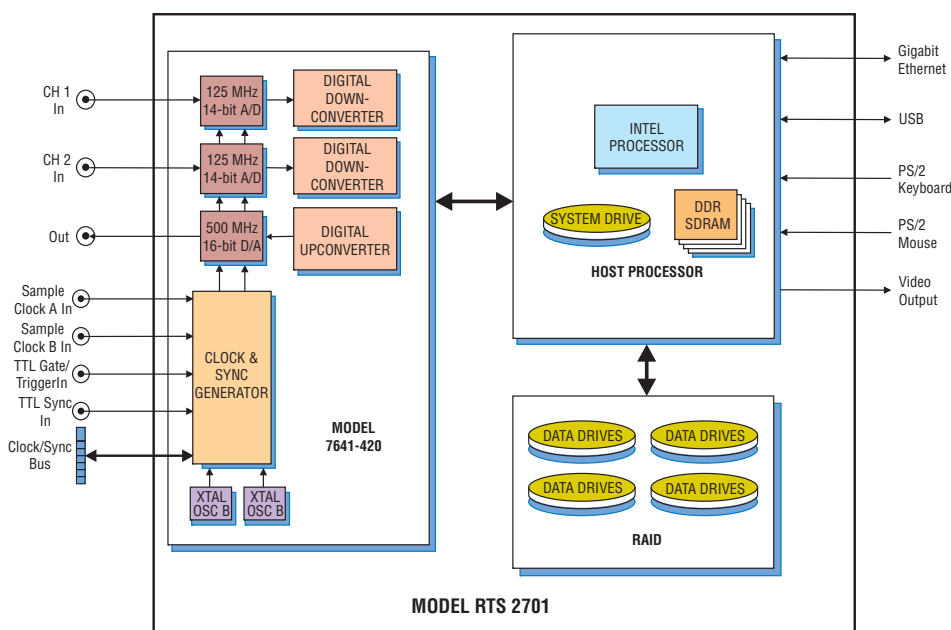

► SystemFlow Graphical User Interface

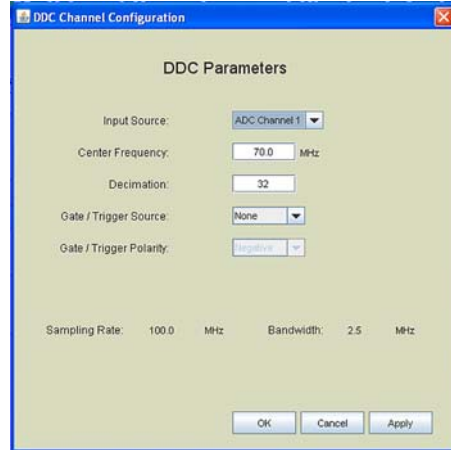
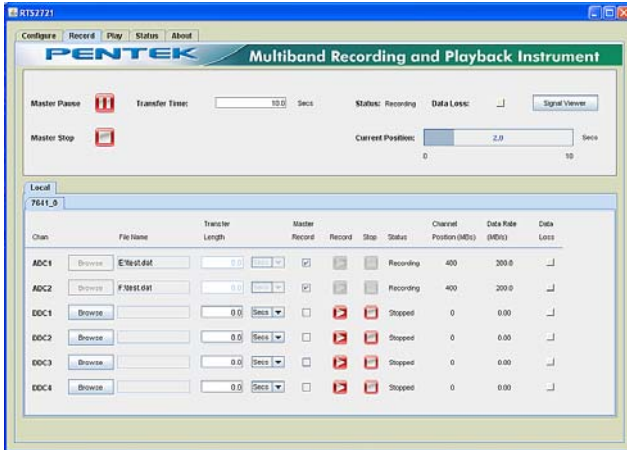

SystemFlow Recorder Interface

The RTS 2701 GUI provides the user with a control interface for the recording system. It includes Configuration, Record, Playback and Status screens, each with intuitive controls and indicators. The user can easily move between screens to set configuration parameters, control and monitor a recording, play back a recorded signal and monitor board temperature and voltage levels. The signal viewer, integrated into the recording GUI, allows the user to monitor real-time signals or recorded signals on disk.

SystemFlow Hardware Configuration Interface

The RTS 2701's configuration screens provide a simple and intuitive means for setting up the system parameters. The DDC configuration screen shown here, provides entries for input source, center frequency, decimation, as well as gate and trigger information. All parameters contain limit-checking and integrated help to provide an easier-to-use out-of-the-box experience.

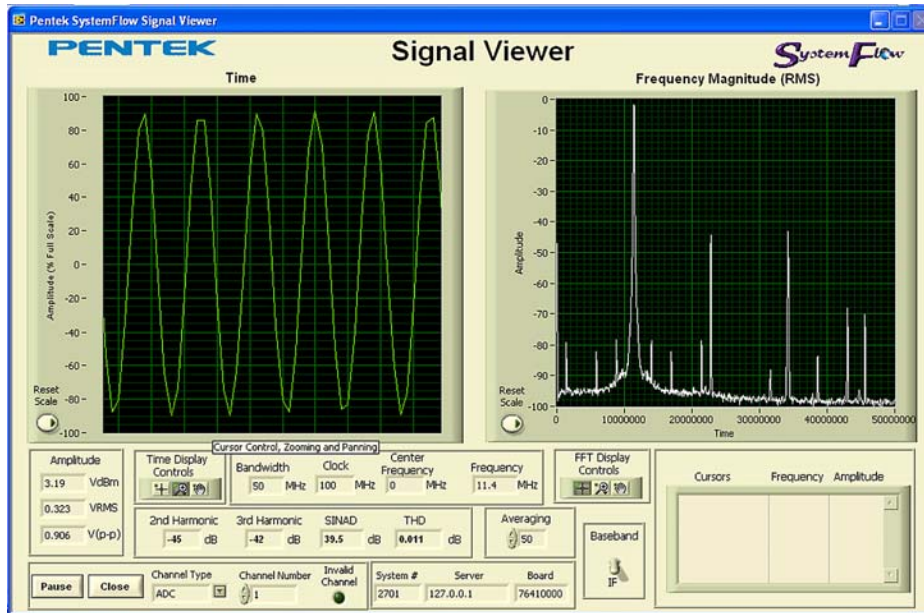

SystemFlow Signal Viewer

The SystemFlow Signal Viewer includes a virtual oscilloscope and spectrum analyzer for signal monitoring in both the time and frequency domains. It is extremely useful for previewing live inputs prior to recording, and for monitoring signals as they are being recorded to help ensure successful recording sessions. The viewer can also be used to inspect and analyze the recorded files after the recording is complete.

Advanced signal analysis capabilities include automatic calculators for signal amplitude and frequency, second and third harmonic components, THD (total harmonic distortion) and SINAD (signal to noise and distortion). With time and frequency zoom, panning modes and dual annotated cursors to mark and measure points of interest, the SystemFlow Signal Viewer can often eliminate the need for a separate oscilloscope or spectrum analyzer in the field. ►

► A/D Performance

Spurious Free Dynamic Range

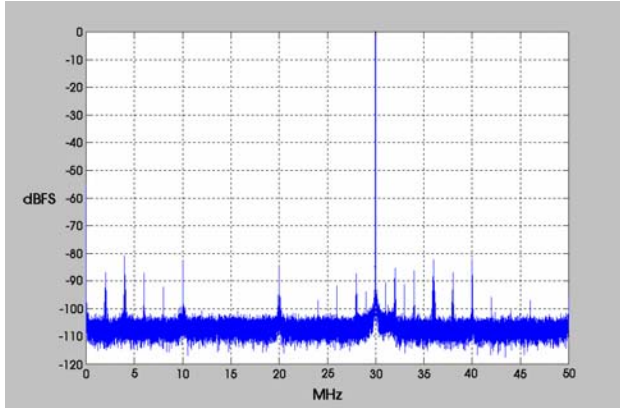

$f_{in} = 70 \text{ MHz}, f_s = 100 \text{ MHz}$

Spurious Pickup

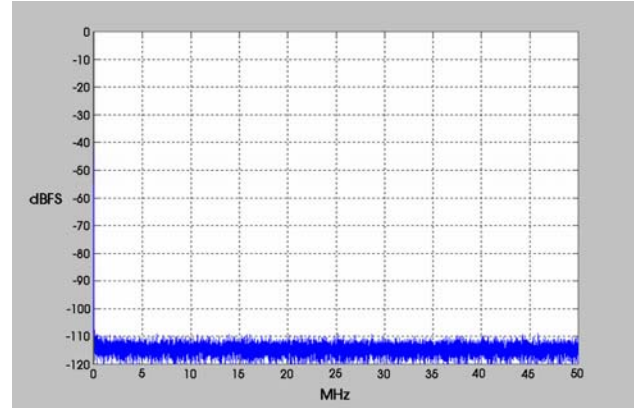

$f_s = 100 \text{ MHz}, 32k \text{ point FFT}, 8 \text{ averages}$

Input Frequency Response

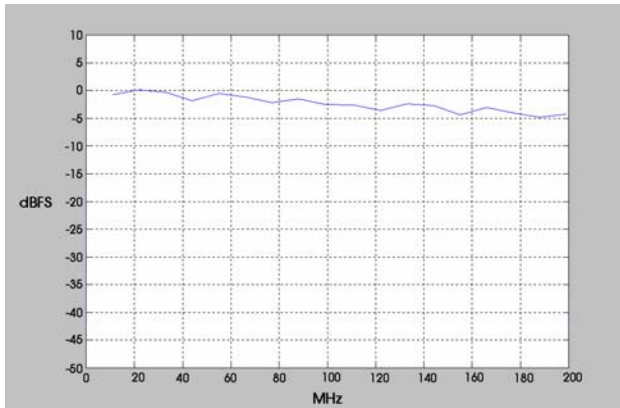

$f_s = 100 \text{ MHz}$

Two-Tone SFDR

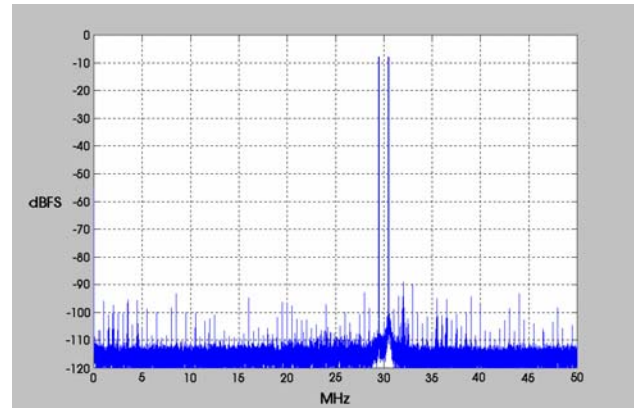

$f_1 = 29.5 \text{ MHz}, f_2 = 30.5 \text{ MHz}, f_s = 100 \text{ MHz}$

Crosstalk

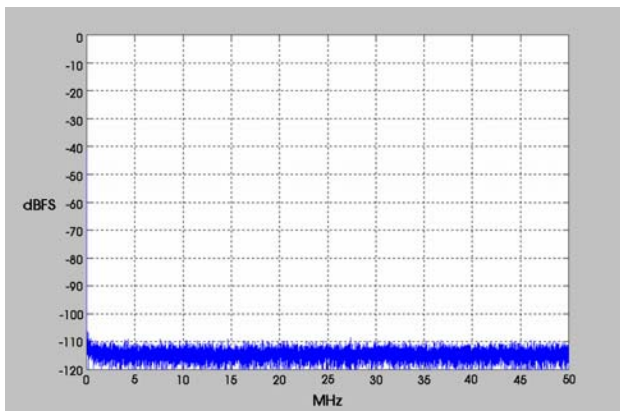

$f_{in \text{ Ch2}} = 69 \text{ MHz}, f_s = 100 \text{ MHz}, \text{ Ch 1 shown}$

Phase Noise

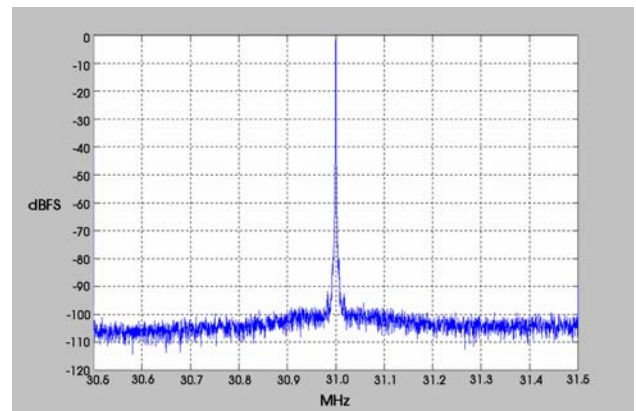

$f_{in} = 69 \text{ MHz}, f_s = 100 \text{ MHz}$

Phase Noise @ 100 kHz = $-102 - 10 \cdot \log(610) = -129.8 \text{ dB/Hz}$



► D/A Performance

Two-Tone Intermodulation Distortion

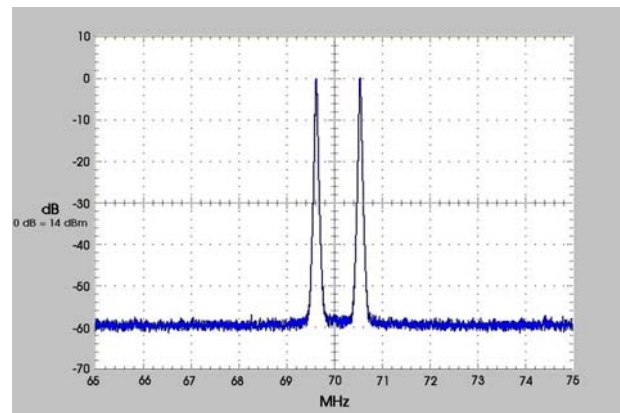

$$f_1 = 69.5 \text{ MHz}, f_2 = 70.5 \text{ MHz}, f_s = 100 \text{ MHz}$$

Specifications**PC Workstation (standard configuration)****Operating System:** Windows XP Professional**Processor:** Intel® processor**Speed:** 1.8 GHz or greater**SDRAM:** 2 GBytes**RAID****Storage:** 4 TB**Number of Drives:** 10**Supported Levels:** 0, 1, 5, 6, 10 and 50**Analog Recording Input / Output****Analog Signal Inputs****Quantity:** 2**Input Type:** Transformer-coupled, front panel female MMCX connectors**Transformer Type:** Coil Craft WBC1-1TLB**Full Scale Input:** +10 dBm into 50 ohms**3 dB Passband:** 250 kHz to 300 MHz**A/D Converters****Type:** Linear Technologies LTC2255**Sampling Rate:** 1 MHz to 125 MHz**Resolution:** 14 bits**Digital Downconverter****Type:** TI/Graychip GC4016 and Pentek-installed DDC IP Core**Number of Channels:** 4**Decimation:** 2 to 32,768**Bandwidth:** 8 kHz to 60 MHz**Analog Signal Outputs****Quantity:** 1**Output Type:** Transformer-coupled, front panel female MMCX connectors**Full Scale Output:** +4 dBm into 50 ohms**3 dB Passband:** 60 kHz to 300 MHz**Digital Upconverter****Type:** TI DAC5686 and Pentek-installed interpolation IP core**Interpolation:** 2 to 32,768**Input Bandwidth:** 40 MHz, max.**Output IF:** DC to 160 MHz**Output Signal:** Analog, real or quadrature**Sampling Rate:** 320 MHz max.; 500 MHz max. with upconversion disabled**Resolution:** 16 bits**Clock Sources (2):** Selectable from onboard 100 and 200 MHz crystal oscillators, external or LVDS clocks (Option -136)**External Clocks (2)****Type:** Front panel female MMCX connector, sine wave, 0 to +10 dBm, AC-coupled, 50 ohms, 1 to 125 MHz**Multi-Recorder Sync/Gate Bus:** 26-pin connector, dual clock/sync/gate input/output LVDS buses; one sync/gate input TTL signal**Physical and Environmental****Size:** 19" W x 21" D x 7" H**Weight:** 60 lb**Operating Temp:** 0° to +50° C**Storage Temp:** -40° to +85° C**Relative Humidity:** 5 to 95%, non-condensing

Specifications are subject to change without notice.

Sample Storage Configurations							
Record Mode	Number of Channels	RAID Level	A/D Sample Rate	DDC Decimation	Max. Recorded Signal Bandwidth*	Total Storage Capacity	Total Record Time
A/D	2	0	120 MHz	n/a	60 MHz	4 TB	127 min.
A/D	2	0	100 MHz	n/a	50 MHz	4 TB	166 min.
A/D	2	5	100 MHz	n/a	50 MHz	4 TB	166 min.
A/D	1	0	125 MHz	n/a	62.5 MHz	2 TB	133 min.
DDC	2	0	125 MHz	8	12.5 MHz	4 TB	8.8 hrs.
DDC	2	5	100 MHz	32	2.5 MHz	4 TB	44 hrs.

* For A/D outputs: Bandwidth = $f_s/2$ (Nyquist rate); for DDC outputs: Bandwidth = $80\% * f_s / \text{Decimation factor}$