



Features

- Complete radar and software radio interface solution
- Supports Xilinx Virtex-6 LXT and SXT FPGAs
- Four 200 MHz 16-bit A/Ds
- Four multiband DDCs
- Multiboard programmable beamformer
- Up to 2 GB of DDR3 SDRAM or 32 MB of QDRII+ SRAM
- Sample clock synchronization to an external system reference
- LVPECL clock/sync bus for multiboard synchronization
- PCI Express (Gen. 1 & 2) interface up to x8
- Optional LVDS connections to the Virtex-6 FPGA for custom I/O

General Information

Model 78661 is a member of the Cobalt® family of high performance PCIe boards based on the Xilinx Virtex-6 FPGA. A multi-channel, high-speed data converter with programmable DDCs (digital downconverters), it is suitable for connection to HF or IF ports of a communications or radar system. Its built-in data capture feature offers an ideal turnkey solution.

It includes four A/Ds, and four banks of memory. In addition to supporting PCI Express Gen. 2 as a native interface, the Model 78661 includes an optional general-purpose connector for application-specific I/O.

The Cobalt Architecture

The Pentek Cobalt Architecture features a Virtex-6 FPGA. All of the board's data and control paths are accessible by the FPGA, enabling factory-installed functions including data multiplexing, channel selection, data packing, gating, triggering and memory control. The Cobalt Architecture organizes the FPGA as a container for data processing applications where each function exists as an intellectual property (IP) module.

Each member of the Cobalt family is delivered with factory-installed applications ideally matched to the board's analog interfaces. The 78661 factory-installed functions include four A/D acquisition IP modules.

Each of the four acquisition IP modules contains a powerful, programmable DDC (Digital Downconverter) IP core. IP modules for either DDR3 or QDRII+ memories, a controller for all data clocking and synchro-

nization functions, a test signal generator, a programmable beamforming IP core, an Aurora gigabit serial interface, and a PCIe interface complete the factory-installed functions and enable the 78661 to operate as a complete turnkey solution without the need to develop any FPGA IP.

Extendable IP Design

For applications that require specialized function, users can install their own custom IP for data processing. Pentek GateFlow FPGA Design Kits include all of the factory installed modules as documented source code. Developers can integrate their own IP with the Pentek factory-installed functions or use the GateFlow kit to completely replace the Pentek IP with their own.

Xilinx Virtex-6 FPGA

The Virtex-6 FPGA site can be populated with two different FPGAs to match the specific requirements of the processing task. Supported FPGAs include: LX240T or SX315T. The SXT part features 1344 DSP48E slices and is ideal for modulation/demodulation, encoding/decoding, encryption/decryption, and channelization of the signals between transmission and reception. For applications not requiring large DSP resources, the lower-cost LXT FPGA can be installed.

Option -104 connects 20 pairs of LVDS signals from the FPGA on PMC P14 to a 68-pin DIL ribbon-cable header on the PCIe board for custom I/O. ➤

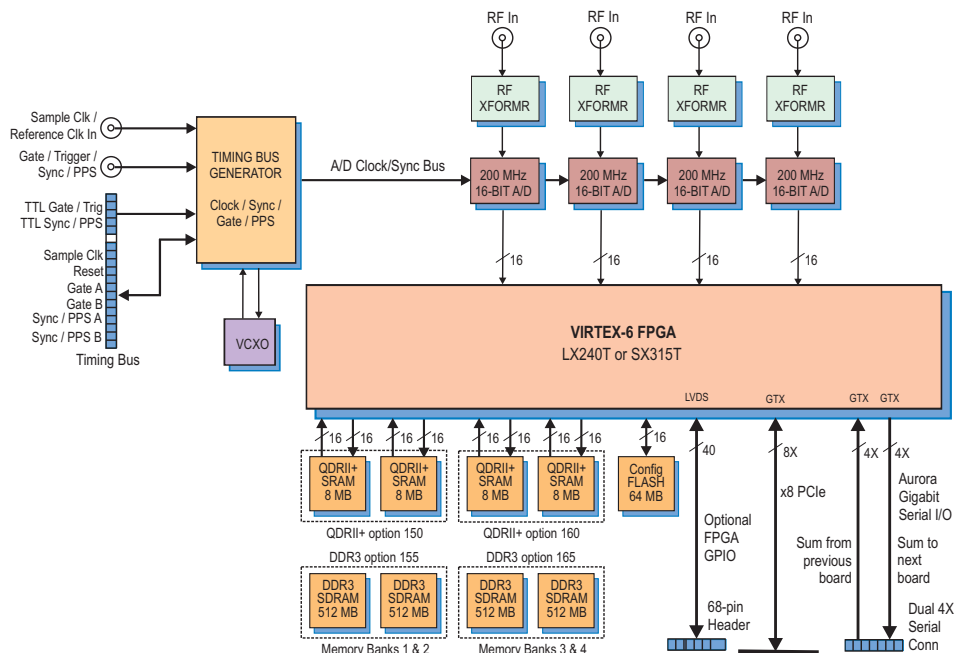

A/D Acquisition IP Modules

The 78661 features four A/D Acquisition IP Modules for easily capturing and moving data. Each IP module can receive data from any of the four A/Ds or a test signal generator

Each IP module has an associated memory bank for buffering data in FIFO mode or for storing data in transient capture mode. All memory banks are supported with DMA engines for easily moving A/D data through the PCIe interface. These powerful linked-list DMA engines are capable of a unique Acquisition Gate Driven mode. In this mode, the length of a transfer performed by a link definition need not be known prior to data acquisition; rather, it is governed by the length of the acquisition gate. This is extremely useful in applications where an external gate drives acquisition and the exact length of that gate is not known or is likely to vary.

For each transfer, the DMA engine can automatically construct metadata packets containing A/D channel ID, a sample-accurate time stamp and data length information. These actions simplify the host processor's job of identifying and executing on the data.

DDC IP Cores

Within each A/D Acquisition IP Module is a powerful DDC IP core. Because of the flexible input routing of the A/D Acquisition IP Modules, many different configurations can be achieved including one A/D driving all four DDCs or each of the four A/Ds driving its own DDC.

Each DDC has an independent 32-bit tuning frequency setting that ranges from DC to f_s , where f_s is the A/D sampling frequency. Each DDC can have its own unique decimation setting, supporting as many as four different output bandwidths for the board. Decimations can be programmed from 2 to 65,536

providing a wide range to satisfy most applications.

The decimating filter for each DDC accepts a unique set of user-supplied 18-bit coefficients. The 80% default filters deliver an output bandwidth of $0.8 \cdot f_s / N$, where N is the decimation setting. The rejection of adjacent-band components within the 80% output bandwidth is better than 100 dB. Each DDC delivers a complex output stream consisting of 24-bit I + 24-bit Q or 16-bit I + 16-bit Q samples at a rate of f_s / N .

Beamformer IP Core

In addition to the DDCs, the 78661 features a complete beamforming subsystem. Each DDC core contains programmable I & Q phase and gain adjustments followed by a power meter that continuously measures the individual average power output. The time constant of the averaging interval for each meter is programmable up to 8K samples. The power meters present average power measurements for each DDC core output in easy-to-read registers.

In addition, each DDC core includes a threshold detector to automatically send an interrupt to the processor if the average power level of any DDC core falls below or exceeds a programmable threshold.

A programmable summation block provides summing of any of the four DDC core outputs. An additional programmable gain stage compensates for summation

change bit growth. A power meter and threshold detect block is provided for the summed output. The output is then directed back into the A/D Acquisition IP Module 1 FIFO for reading over the PCIe. For larger systems, multiple 78661's can be chained together via a built-in Xilinx Aurora gigabit serial interface through the P16 XMC connector. This allows summation across channels on multiple boards.

A/D Converter Stage

The front end accepts three analog HF or IF inputs on front panel SSMC connectors with transformer coupling into three Texas Instruments ADS5485 200 MHz, 16-bit A/D converters.

The digital outputs are delivered into the Virtex-6 FPGA for signal processing, data capture and for routing to other board resources.

Clocking and Synchronization

An internal timing bus provides all timing and synchronization required by the A/D converters. It includes a clock, two sync and two gate or trigger signals. An on-board clock generator receives an external sample clock from the front panel SSMC connector. This clock can be used directly by the A/D or divided by a built-in clock synthesizer circuit. In an alternate mode, the sample clock can be sourced from an on-board programmable voltage

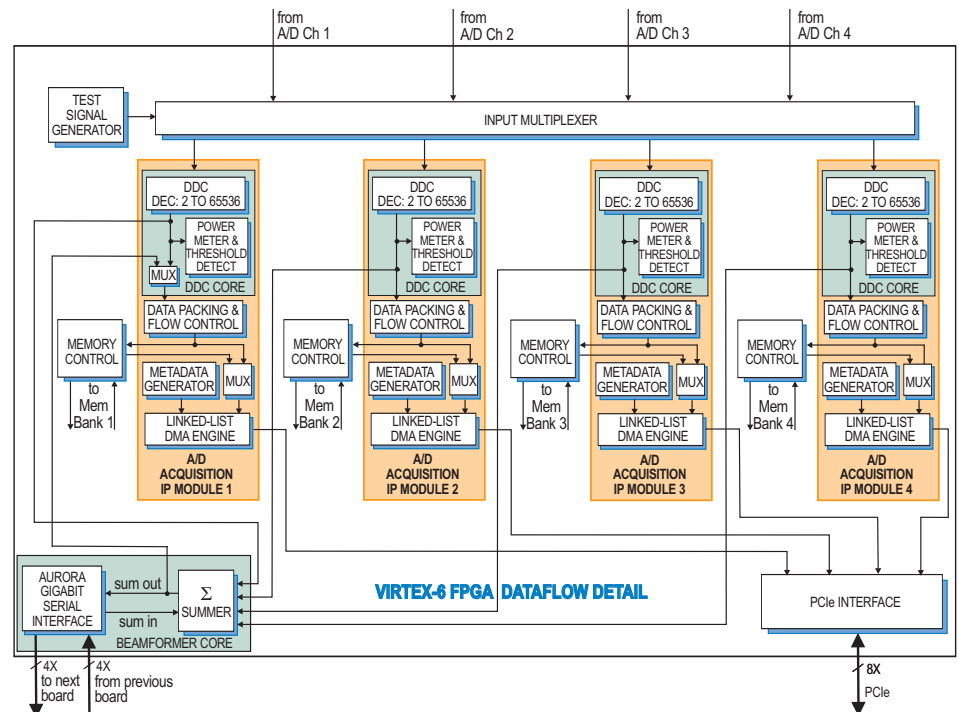

PCI Express Interface

The Model 78661 includes an industry-standard interface fully compliant with PCI Express Gen. 1 & 2 bus specifications. Supporting PCIe Links up to x8, the interface includes multiple DMA controllers for efficient transfers to and from the board.

Model 8266

The Model 8266 is a fully-integrated PC development system for Pentek Cobalt, Onyx and Flexor PCI Express boards. It was created to save engineers and system integrators the time and expense associated with building and testing a development system that ensures optimum performance of Pentek boards.



Ordering Information

Model	Description
78621	4-Channel 200 MHz A/D with DDCs and Virtex-6 FPGA - x8 PCIe

Options:

-062	XC6VLX240T FPGA
-064	XC6VSX315T FPGA
-104	LVDS FPGA I/O through 68-pin ribbon cable connector
-150	Two 8 MB QDR11+ SRAM Memory Banks (Banks 1 and 2)
-160	Two 8 MB QDR11+ SRAM Memory Banks (Banks 3 and 4)
-155	Two 512 MB DDR3 SDRAM Memory Banks (Banks 1 and 2)
-165	Two 512 MB DDR3 SDRAM Memory Banks (Banks 3 and 4)

Model	Description
8266	PC Development System See 8266 Datasheet for Options

► controlled crystal oscillator. In this mode, the front panel SSMC connector can be used to provide a 10 MHz reference clock for synchronizing the internal oscillator.

A front panel 26-pin LVPECL Clock/Sync connector allows multiple boards to be synchronized. In the slave mode, it accepts LVPECL inputs that drive the clock, sync and gate signals. In the master mode, the LVPECL bus can drive the timing signals for synchronizing multiple boards.

Multiple 78661's can be driven from the LVPECL bus master, supporting synchronous sampling and sync functions across all connected boards.

Memory Resources

The 78661 architecture supports up to four independent memory banks which can be configured with all QDR11+ SRAM, DDR3 SDRAM, or as combination of two banks of each type of memory.

Each QDR11+ SRAM bank can be up to 8 MB deep and is an integral part of the board's DMA capabilities, providing FIFO memory space for creating DMA packets. For applications requiring deeper memory resources, DDR3 SDRAM banks can each be up to 512 MB deep. Built-in memory functions include multichannel A/D data capture, tagging and streaming.

In addition to the factory installed functions, custom user-installed IP within the FPGA can take advantage of the memories for many other purposes.

Specifications

Front Panel Analog Signal Inputs

Input Type: Transformer-coupled, front panel female SSMC connectors
Transformer Type: Coil Craft WBC4-6TLB
Full Scale Input: +8 dBm into 50 ohms
3 dB Passband: 300 kHz to 700 MHz

A/D Converters

Type: Texas Instruments ADS5485
Sampling Rate: 10 MHz to 200 MHz
Resolution: 16 bits

Digital Downconverters

Quantity: Four channels
Decimation Range: 2x to 65,536x in two stages of 2x to 256x
LO Tuning Freq. Resolution: 32 bits, 0 to f_s
LO SFDR: >120 dB
Phase Offset Resolution: 32 bits, 0 to 360 degrees
FIR Filter: 18-bit coefficients, 24-bit output, with user programmable coefficients
Default Filter Set: 80% bandwidth, <0.3 dB passband ripple, >100 dB stopband attenuation

Beamformer

Summation: Four channels on-board; multiple boards can be summed via Summation Expansion Chain

Summation Expansion Chain: One chain in and one chain out link via XMC connector using Aurora protocol

Phase Shift Coefficients: I & Q with 16-bit resolution

Gain Coefficients: 16-bit resolution

Channel Summation: 24-bit

Multiboard Summation Expansion: 32-bit

Sample Clock Sources: On-board clock synthesizer

Clock Synthesizer

Clock Source: Selectable from on-board programmable VCXO (10 to 810 MHz), front panel external clock or LVPECL timing bus

Synchronization: VCXO can be locked to an external 4 to 180 MHz PLL system reference, typically 10 MHz

Clock Dividers: External clock or VCXO can be divided by 1, 2, 4, 8, or 16 for the A/D clock

External Clock

Type: Front panel female SSMC connector, sine wave, 0 to +10 dBm, AC-coupled, 50 ohms, accepts 10 to 800 MHz divider input clock or PLL system reference

Timing Bus: 26-pin connector LVPECL bus includes, clock/sync/gate/PPS inputs and outputs; TTL signal for gate/trigger and sync/PPS inputs

External Trigger Input

Type: Front panel female SSMC connector, LVTTTL

Function: Programmable functions include: trigger, gate, sync and PPS

Field Programmable Gate Array

Standard: Xilinx Virtex-6 XC6VLX240T
Optional: Xilinx Virtex-6 XC6VSX315T

Custom I/O

Option -104: Connects 20 pairs of LVDS signals from the FPGA on PMC P14 to a 68-pin DIL ribbon-cable header on the PCIe board for custom I/O.

Memory

Option 150 or 160: Two 8 MB QDR11+ SRAM memory banks, 400 MHz DDR
Option 155 or 165: Two 512 MB DDR3 SDRAM memory banks, 400 MHz DDR

PCI-Express Interface

PCI Express Bus: Gen. 1: x4 or x8; Gen. 2: x4

Environmental

Operating Temp: 0° to 50° C

Storage Temp: -20° to 90° C

Relative Humidity: 0 to 95%, non-cond.

Size: Half length PCIe card, 4.38 in. x 7.13 in.

A/D Performance

Spurious Free Dynamic Range

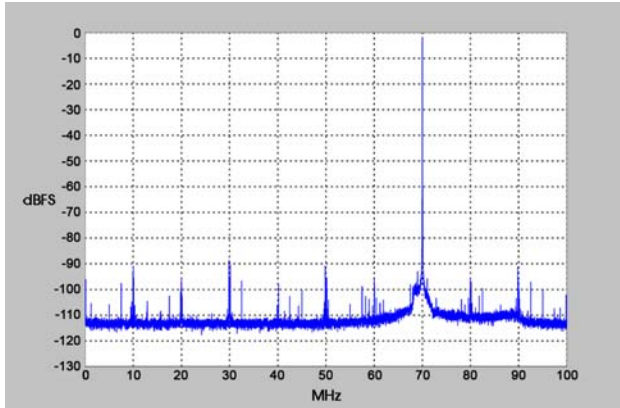

$f_{in} = 70 \text{ MHz}$, $f_s = 200 \text{ MHz}$, Internal Clock

Spurious Pick-up

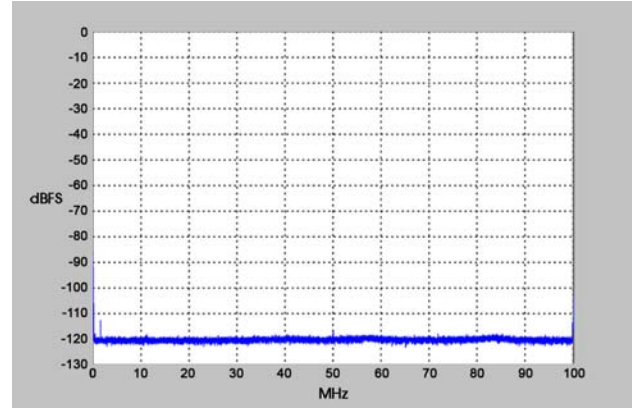

$f_s = 200 \text{ MHz}$, Internal Clock

Two-Tone SFDR

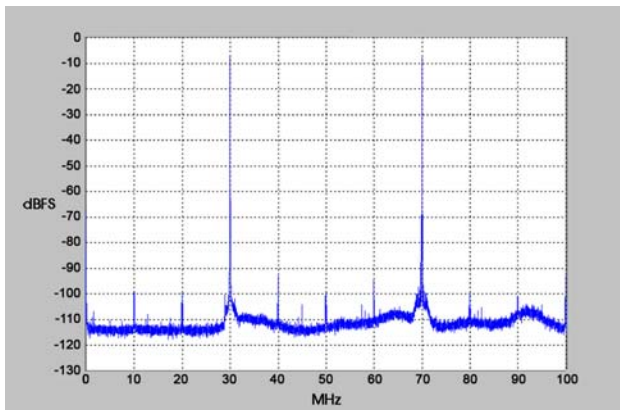

$f_1 = 30 \text{ MHz}$, $f_2 = 70 \text{ MHz}$, $f_s = 200 \text{ MHz}$

Two-Tone SFDR

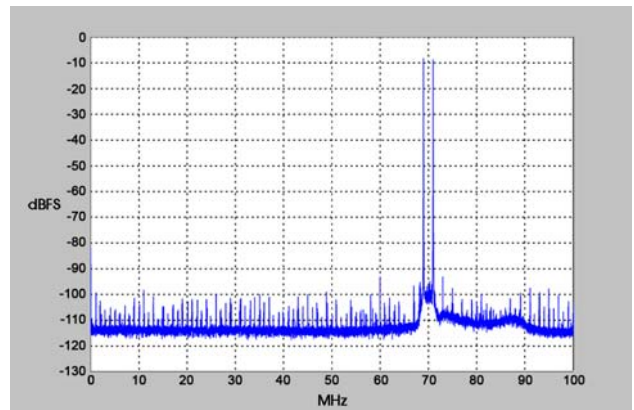

$f_1 = 69 \text{ MHz}$, $f_2 = 71 \text{ MHz}$, $f_s = 200 \text{ MHz}$

Adjacent Channel Crosstalk

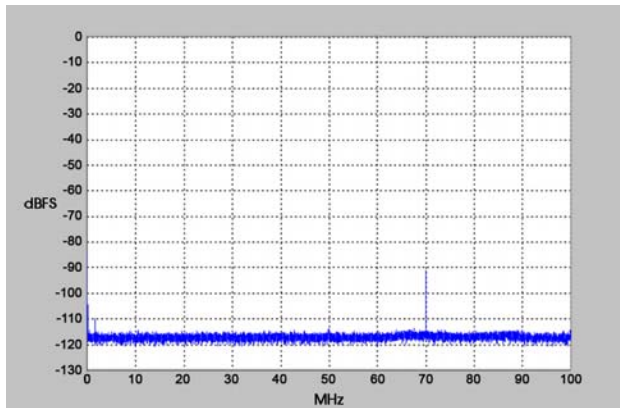

$f_{in \text{ Ch2}} = 70 \text{ MHz}$, $f_s = 200 \text{ MHz}$, Ch 1 shown

Input Frequency Response

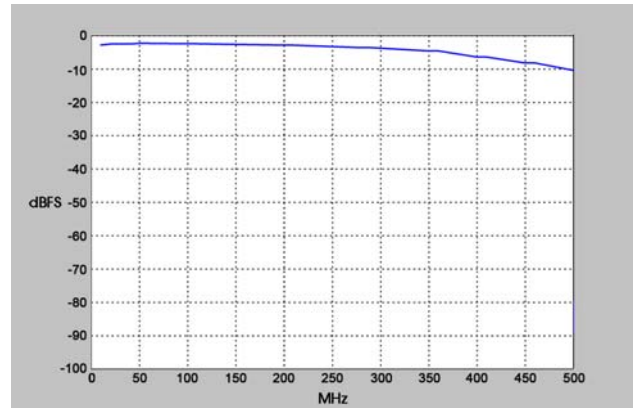

$f_s = 200 \text{ MHz}$, Internal Clock