



Features

- Complete radar and software radio interface solution
- Supports Xilinx Virtex-6 LXT and SXT FPGAs
- Three 200 MHz 16-bit A/Ds
- One digital upconverter
- Two 800 MHz 16-bit D/As
- Up to 2 GB of DDR3 SDRAM or 32 MB of QDRII+ SRAM
- Sample clock synchronization to an external system reference
- LVPECL clock/sync bus for multiboard synchronization
- PCI Express (Gen. 1 & 2) interface up to x8
- Optional user-configurable gigabit serial interface
- Optional LVDS connections to the Virtex-6 FPGA for custom I/O

General Information

Model 78620 is a member of the Cobalt® family of high performance PCIe boards based on the Xilinx Virtex-6 FPGA. A multi-channel, high-speed data converter, it is suitable for connection to HF or IF ports of a communications or radar system. Its built-in data capture and playback features offer an ideal turnkey solution.

It includes three A/Ds, two D/As and four banks of memory. In addition to supporting PCI Express Gen. 2 as a native interface, the Model 78620 includes optional general-purpose and gigabit serial card edge connectors for application-specific I/O.

The Cobalt Architecture

The Pentek Cobalt Architecture features a Virtex-6 FPGA. All of the board's data and control paths are accessible by the FPGA, enabling factory-installed functions including data multiplexing, channel selection, data packing, gating, triggering and memory control. The Cobalt Architecture organizes the FPGA as a container for data processing applications where each function exists as an intellectual property (IP) module.

Each member of the Cobalt family is delivered with factory-installed applications ideally matched to the board's analog interfaces. The 78620 factory-installed functions include three A/D acquisition and a D/A waveform playback IP modules, ideally matched to the board's analog interfaces. IP modules for either DDR3 or QDRII+ memories, a controller for all data clocking and synchronization functions, a test signal generator,

and a PCIe interface complete the factory-installed functions and enable the 78620 to operate as a complete turnkey solution, without the need to develop any FPGA IP.

Extendable IP Design

For applications that require specialized functions, users can install their own custom IP for data processing. Pentek GateFlow FPGA Design Kits include all of the factory-installed modules as documented source code. Developers can integrate their own IP with the Pentek factory-installed functions or use the GateFlow kit to completely replace the Pentek IP with their own.

Xilinx Virtex-6 FPGA

The Virtex-6 FPGA site can be populated with a variety of different FPGAs to match the specific requirements of the processing task. Supported FPGAs include: LX130T, LX240T, or SX315T. The SXT part features 1344 DSP48E slices and is ideal for modulation/demodulation, encoding/decoding, encryption/decryption, and channelization of the signals between transmission and reception. For applications not requiring large DSP resources, one of the lower-cost LXT FPGAs can be installed.

Option -104 connects 20 pairs of LVDS signals from the FPGA on PMC P14 to a 68-pin DIL ribbon-cable header on the PCIe board for custom I/O.

Option -105 connects two 4X gigabit serial links from the FPGA on XMC P16 to two 4X gigabit serial connectors along the top edge of the PCIe board. ➤

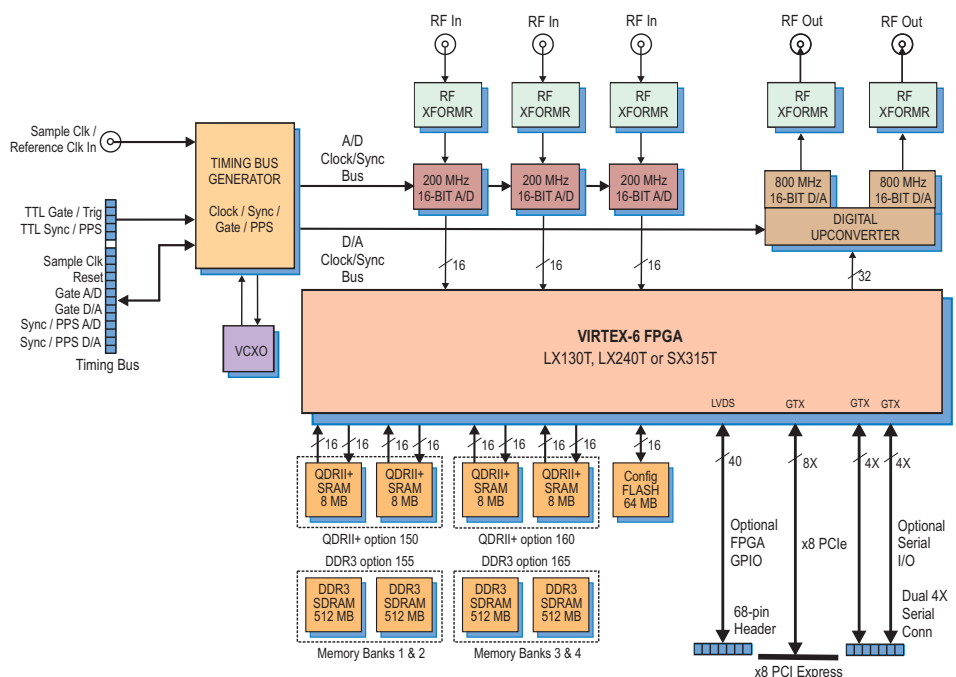

A/D Acquisition IP Modules

The 78620 features three A/D Acquisition IP Modules for easily capturing and moving data. Each module can receive data from any of the three A/Ds, a test signal generator or from the D/A Waveform Playback IP Module in loopback mode.

Each IP module has an associated memory bank for buffering data in FIFO mode or for storing data in transient capture mode. All memory banks are supported with DMA engines for easily moving A/D data through the PCIe interface.

These powerful linked-list DMA engines are capable of a unique Acquisition Gate Driven mode. In this mode, the length of a transfer performed by a link definition need not be known prior to data acquisition; rather, it is governed by the length of the acquisition gate. This is extremely useful in applications where an external gate drives acquisition and the exact length of that gate is not known or is likely to vary.

For each transfer, the DMA engine can automatically construct metadata packets containing A/D channel ID, a sample-accurate time stamp and data length information. These actions simplify the host processor's job of identifying and executing on the data.

D/A Waveform Playback IP Module

The Model 78620 factory-installed functions include a sophisticated D/A Waveform Playback IP module. A linked-list controller allows users to easily play back to the dual D/A waveforms stored in either on-board memory or off-board host memory.

Parameters including length of waveform, delay from playback trigger, waveform repetition, etc. can be programmed for each waveform.

Up to 64 individual link entries can be chained together to create complex waveforms with a minimum of programming.

A/D Converter Stage

The front end accepts three full-scale analog HF or IF inputs on front panel SSMC connectors at +8 dBm into 50 ohms with transformer coupling into three Texas Instruments ADS5485 200 MHz, 16-bit A/D converters.

The digital outputs are delivered into the Virtex-6 FPGA for signal processing, data capture or for routing to other module resources.

Digital Upconverter and D/A Stage

A TI DAC5688 DUC (digital upconverter) and D/A accepts a baseband real or complex data stream from the FPGA and provides that input to the upconvert, interpolate and dual D/A stages.

When operating as a DUC, it interpolates and translates real or complex baseband input signals to any IF center frequency up to 360 MHz. It delivers real or quadrature (I+Q) analog outputs to the dual 16-bit D/A converter. Analog output is through a pair of front panel SSMC connectors.

If translation is disabled, the DAC5688 acts as a dual interpolating 16-bit D/A with output sampling rates up to 800 MHz. In both modes the DAC5688 provides interpolation factors of 2x, 4x and 8x.

Clocking and Synchronization

Two internal timing buses provide either a single clock or two different clock rates to the A/D and D/A signal paths.

Each timing bus includes a clock, sync and a gate or trigger signal. An on-board clock generator receives an external sample clock from the front panel SSMC connector. This clock can be used directly for either the A/D or D/A sections or can be divided by a built-in clock synthesizer circuit to provide different A/D and D/A clocks. In an alternate mode, the sample clock can be sourced from an on-board programmable VCXO (Voltage-Controlled Crystal Oscillator). In this mode, the front panel SSMC connector can be used to provide a 10 MHz reference clock for synchronizing the internal oscillator.

A front panel 26-pin LVPECL Clock/Sync connector allows multiple boards to be synchronized. In the slave mode, it accepts LVPECL inputs that drive the clock, sync and gate signals. In the master mode, the LVPECL bus can drive the timing signals for synchronizing multiple boards.

Multiple 78620's can be driven from the LVPECL bus master, supporting synchronous sampling and sync functions across all connected boards.

Memory Resources

The 78620 architecture supports up to four independent memory banks which can be configured with all QDRII+ SRAM, DDR3 SDRAM, or as combination of two banks of each type of memory.

Each QDRII+ SRAM bank can be up to 8 MB deep and is an integral part of the

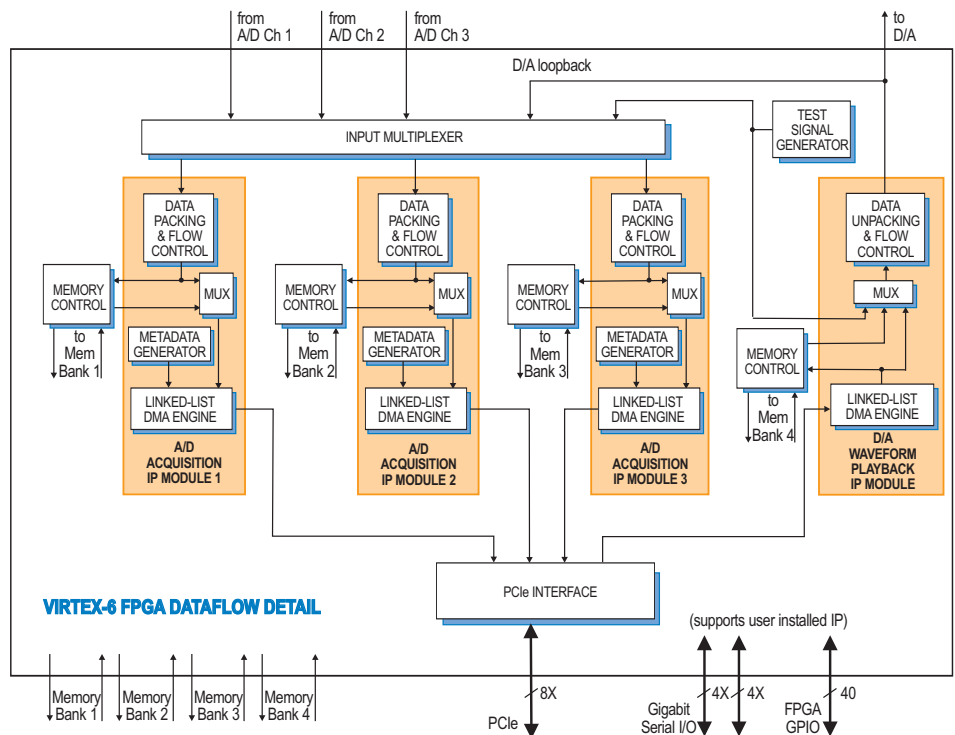

Model 8266

The Model 8266 is a fully-integrated PC development system for Pentek Cobalt, Onyx and Flexor PCI Express boards. It was created to save engineers and system integrators the time and expense associated with building and testing a development system that ensures optimum performance of Pentek boards.



Ordering Information

Model	Description
78620	3-Channel 200 MHz A/D and 2-Channel 800 MHz D/A with Virtex-6 FPGA - PCIe
Options:	
-062	XC6VLX240T FPGA
-064	XC6VSX315T FPGA
-104	LVDS FPGA I/O through 68-pin ribbon cable connector
-105	Gigabit serial FPGA I/O through two 4X top edge connectors
-150	Two 8 MB QDRII+ SRAM Memory Banks (Banks 1 and 2)
-160	Two 8 MB QDRII+ SRAM Memory Banks (Banks 3 and 4)
-155	Two 512 MB DDR3 SDRAM Memory Banks (Banks 1 and 2)
-165	Two 512 MB DDR3 SDRAM Memory Banks (Banks 3 and 4)

Model	Description
8266	PC Development System. See 8266 Datasheet for Options

► board's DMA capabilities, providing FIFO memory space for creating DMA packets. For applications requiring deep memory resources, DDR3 SDRAM banks can each be up to 512 MB deep. Built-in memory functions include an A/D data transient capture mode and D/A waveform playback mode.

In addition to the factory installed functions, custom user-installed IP within the FPGA can take advantage of the memories for many other purposes.

PCI Express Interface

The Model 78620 includes an industry-standard interface fully compliant with PCI Express Gen. 1 & 2 bus specifications. Supporting PCIe links up to x8, the interface includes multiple DMA controllers for efficient transfers to and from the board.

Specifications

Front Panel Analog Signal Inputs

Input Type: Transformer-coupled, front panel female SSMC connectors
Transformer Type: Coil Craft WBC4-6TLB
Full Scale Input: +8 dBm into 50 ohms
3 dB Passband: 300 kHz to 700 MHz

A/D Converters

Type: Texas Instruments ADS5485
Sampling Rate: 10 MHz to 200 MHz
Resolution: 16 bits

D/A Converters

Type: Texas Instruments DAC5688
Input Data Rate: 250 MHz max.
Output IF: DC to 400 MHz max.
Output Signal: 2-channel real or 1-channel with frequency translation
Output Sampling Rate: 800 MHz max. with interpolation
Resolution: 16 bits

Front Panel Analog Signal Outputs

Output Type: Transformer-coupled, front panel female SSMC connectors
Transformer Type: Coil Craft WBC4-6TLB
Full Scale Output: +4 dBm into 50 ohms
3 dB Passband: 300 kHz to 700 MHz

Sample Clock Sources: On-board clock synthesizer generates two clocks: one A/D clock and one D/A clock

Clock Synthesizer

Clock Source: Selectable from on-board programmable VCXO (10 to 810 MHz), front panel external clock or LVPECL timing bus

Synchronization: VCXO can be locked to an external 4 to 180 MHz PLL system reference, typically 10 MHz

Clock Dividers: External clock or VCXO can be divided by 1, 2, 4, 8, or 16 for the A/D clock

External Clock

Type: Front panel female SSMC connector, sine wave, 0 to +10 dBm, AC-coupled, 50 ohms, accepts 10 to 800 MHz sample clock or PLL system reference

Timing Bus: 26-pin connector LVPECL bus includes, clock/sync/gate/PPS inputs and outputs; TTL signal for gate/trigger and sync/PPS inputs

Field Programmable Gate Array

Standard: Xilinx Virtex-6 XC6VLX130T
Optional: Xilinx Virtex-6 XC6VLX240T or XC6VSX315T

Custom I/O

Option -104: Connects 20 pairs of LVDS signals from the FPGA on PMC P14 to a 68-pin DIL ribbon-cable header on the PCIe board for custom I/O.

Option -105: Connects two 4X gigabit serial links from the FPGA on XMC P16 to two 4X gigabit serial connectors along the top edge of the PCIe board

Memory

Option 150 or 160: Two 8 MB QDRII+ SRAM memory banks, 400 MHz DDR
Option 155 or 165: Two 512 MB DDR3 SDRAM memory banks, 400 MHz DDR

PCI-Express Interface

PCI Express Bus: Gen. 1 x4 or x8;
 Gen. 2: x4

Environmental

Operating Temp: 0° to 50° C

Storage Temp: -20° to 90° C

Relative Humidity: 0 to 95%, non-cond.

Size: Half-length PCIe card, 4.38 in. x 7.13 in.

A/D Performance

Spurious Free Dynamic Range

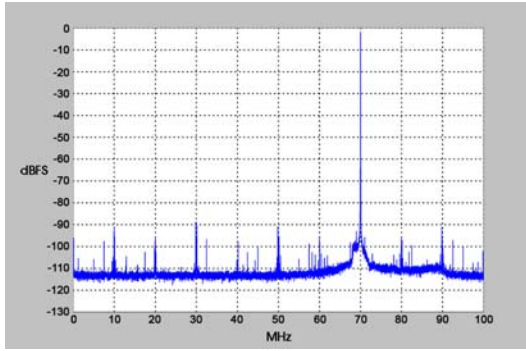

$f_{in} = 70 \text{ MHz}, f_s = 200 \text{ MHz}, \text{Internal Clock}$

Spurious Pick-up

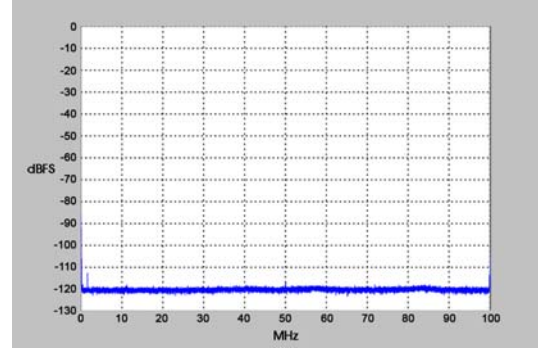

$f_s = 200 \text{ MHz}, \text{Internal Clock}$

Two-Tone SFDR

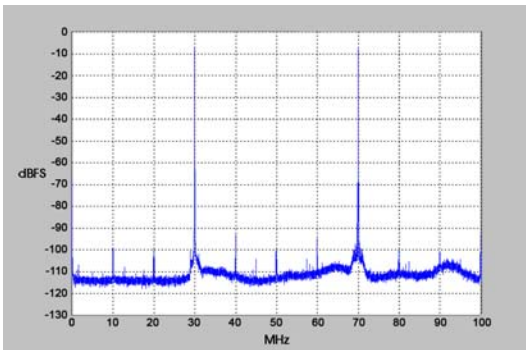

$f_1 = 30 \text{ MHz}, f_2 = 70 \text{ MHz}, f_s = 200 \text{ MHz}$

Two-Tone SFDR

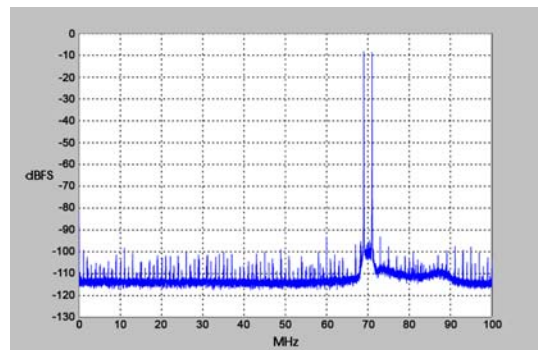

$f_1 = 69 \text{ MHz}, f_2 = 71 \text{ MHz}, f_s = 200 \text{ MHz}$

Adjacent Channel Crosstalk

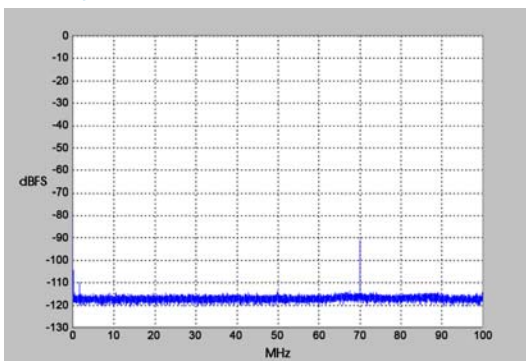

$f_{in \text{ Ch2}} = 70 \text{ MHz}, f_s = 200 \text{ MHz}, \text{Ch 1 shown}$

Input Frequency Response

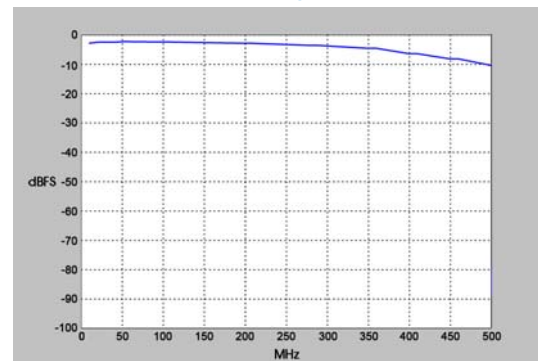

$f_s = 200 \text{ MHz}, \text{Internal Clock}$

Spurious Free Dynamic Range

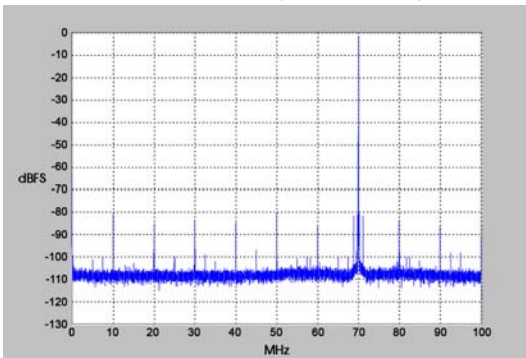

$f_{out} = 70 \text{ MHz}, f_s = 200 \text{ MHz}, \text{Internal Clock}$

D/A Performance

Spurious Free Dynamic Range

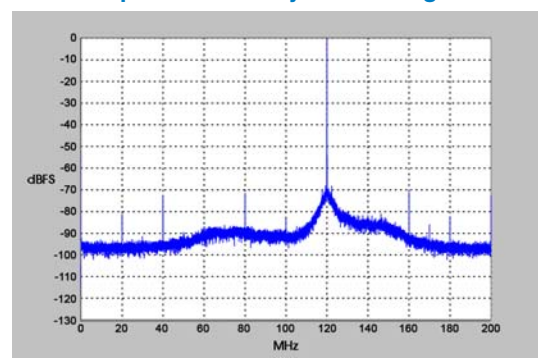

$f_{out} = 140 \text{ MHz}, f_s = 400 \text{ MHz}, \text{External Clock}$