



**General Information**

Model 7641-420 is a half-length PCI Transceiver with Dual Wideband DDC and Interpolation Filter. It consists of one Model 7141-420 transceiver mounted on a PCI carrier board. The Model 7641-420 attaches directly to computer motherboards with PCI bus slots. Front panel connectors are brought out on the rear panel.

The receiver section features two or four LTC2255 125 MHz 14-bit A/D converters and one or two TI GC4016 quad multiband digital downconverter. The digital outputs of the A/Ds are delivered to the Virtex-II Pro FPGAs and to other module resources including the GC4016 which supports a decimation range from 32 to 16,384. For an A/D sample clock frequency of 100 MHz, the output bandwidth for each of the four channels ranges from 2.5 MHz down to 5 kHz. By combining two or four channels, decimations of 16 or 8 can be achieved for an output bandwidth of up to 5 or 10 MHz, respectively.

For applications that require even wider bandwidths, these boards include Pentek's GateFlow Installed Core 420 high-performance wideband DDC, similar in functionality to the GC1012 but with enhanced performance, and an interpolation filter that extends the range of the DAC5686 D/A converter.

**Core 420 Wideband Downconverter**

Like the GC4016, the Core 420 downconverter translates any frequency band within the input bandwidth range down to zero frequency. A complex FIR low pass filter then removes any out of band frequency components. An output decimator and formatter deliver output data in either real or complex representation.

An input gain block scales both I and Q data streams by a 16-bit gain term. The NCO provides over 118 dB spurious-free dynamic range (SFDR).

The mixer utilizes four 18x18-bit multipliers to handle the complex inputs from the NCO and the complex data input samples. The FIR filter is capable of storing and utilizing up to four independent sets of 18-bit coefficients for each decimation value. These coefficients are user-programmable using RAM structures within the FPGA.

Two identical Core 420 DDCs are factory installed in the FPGA. The decimation settings of 2, 4, 8, 16, 32, and 64 provide output bandwidths from 40 MHz down to 1.25 MHz for an A/D sampling rate of 100 MHz. It also delivers better stopband rejection than the GC4016 in combined channel modes.

A multiplexer in front of the Core 420 DDCs allows data to be sourced from either the A/D converters or from the output of the GC4016, extending the maximum cascaded decimation factor to 1,048,576.

**Core 420 Interpolation Filter**

The interpolation filter included in the 420 Core, expands the interpolation factor from 2 to 32,768 programmable in steps of 2, and relieves the host processor from performing upsampling tasks. Including the DUC, the maximum interpolation factor is 32,768 which is comparable to the maximum decimation of the GC4016 narrowband DDC.

In addition to the Core 420, all the standard features of this Model are retained including D/A waveform generator mode, all data routing and formatting, and delay and transient capture memory. ➤

**Features**

- GateFlow Core 420, two high-performance wideband DDCs and interpolation filter, factory-installed
- Extended DDC decimation range of 2 to 1,048,576
- Extended DDC bandwidth range of 40 MHz to 76.3 Hz
- Extended DUC interpolation range of 2 to 32,768
- Extended DUC bandwidth range of 40 MHz to 2.44 kHz

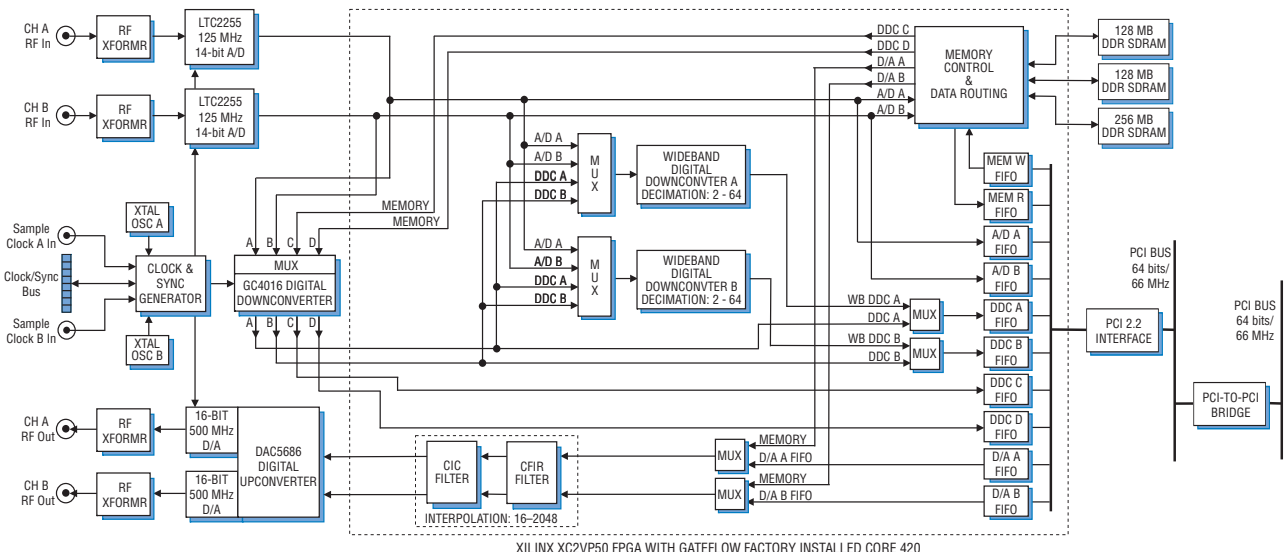

► **Clocking and Synchronization**

Two independent internal timing buses can provide either a single clock or two different clock rates for the input and output signals.

Each timing bus includes a clock, a sync, and a gate or trigger signal. Signals from either Timing Bus A or B can be selected as the timing source for the A/Ds, the down-converter, the upconverter and the D/As. Two external reference clocks are accepted, one for each timing bus and two internal clocks may be used for each timing bus.

A front panel 26-pin LVDS Clock/Sync connector allows multiple boards to be synchronized. In the slave mode, it accepts differential LVDS inputs that drive the clock, sync and gate signals for the two internal timing buses.

In the master mode, the LVDS bus can drive one or both sets of timing signals from the two internal timing buses for synchronizing multiple modules.

Up to seven slave 7641-420's, can be driven from the LVDS bus master, supporting synchronous sampling and sync functions across all connected boards. Up to 80 boards may be synchronized with a Model 9190 Clock and Sync Generator.

**Memory Resources**

Three independent banks of SDRAM are available to the FPGA. Built-in memory functions include an A/D data transient capture mode with pre- and post-triggering; a D/A waveform generator mode; and an A/D data delay mode for applications like tracking receivers.

Custom user-installed functions within the FPGA can take advantage of the SDRAM for many other purposes.

**PCI Interface**

The Model 7641-420 includes an industry-standard interface fully compliant with PCI 2.2 bus specifications. The interface includes nine separate DMA controllers for efficient transfers to and from the module.

Data widths of 32 or 64 bits and data rates of 33 or 66 MHz are supported.

**Specifications**

**Analog Signal Inputs**

**Input Type:** Transformer-coupled, front panel female MMCX connectors  
**Transformer Type:** Coil Craft WBC1-1TLB

**Full Scale Input:** +10 dBm into 50 ohms  
**3 dB Passband:** 250 kHz to 300 MHz

**A/D Converters**

**Type:** Linear Technology LTC2255  
**Sampling Rate:** 1 MHz to 125 MHz  
**Internal Clock:** Crystal oscillator A or B  
**External Clock:** 1 to 125 MHz  
**Resolution:** 14 bits

**Digital Downconverter**

**Type:** TI/Graychip GC4016  
**Decimation:** 32 to 16,384; with channel combining mode: 8 or 16  
**Data Source:** A/D, FPGA, or PCI interface  
**Control Source:** FPGA or PCI interface  
**Output:** Parallel complex data

**Receiver Bypass Mode:** Data from the A/Ds can be written directly into the FPGAs at a rate equal to the A/D clock decimated by any integer between 1 and 4096

**Front Panel Analog Signal Outputs**

**Output Type:** Transformer-coupled, front panel female MMCX connectors  
**Full Scale Output:** +4 dBm into 50 ohms  
**3 dB Passband:** 60 kHz to 300 MHz

**Digital Upconverter**

**Type:** TI DAC5686  
**Input Bandwidth:** 40 MHz, max.  
**Output IF:** DC to 160 MHz  
**Output Signal:** Analog, real or quadrature  
**Sampling Rate:** 320 MHz, max; 500 MHz max. with upconversion disabled  
**Resolution:** 16 bits

**Clock Sources:** Selectable from onboard A or B crystal oscillators, external or LVDS clocks

**External Clocks**

**Type:** Front panel female MMCX connector, sine wave, 0 to +10 dBm, AC-coupled, 50 ohms

**Sync/Gate Bus:** 26-pin connector, dual clock/sync/gate input/output LVDS buses; one sync/gate input TTL signal

**Field Programmable Gate Array**

**Type:** Xilinx Virtex-II Pro XC2VP50

**Memory**

**DDR SDRAM:** 512 MB in three banks  
**FLASH:** One bank of 16 MB.

**PCI Interface**

**PCI Bus:** 64-bit, 66 MHz (also supports 32-bit and/or 33 MHz)  
**Local Bus:** 64-bit, 66 MHz  
**DMA:** 9 channel demand-mode and chaining controller

**Environmental (Commercial version)**

**Operating Temp:** 0° to 50° C  
**Storage Temp:** -20° to 90° C  
**Relative Humidity:** 0 to 95%, non-cond.  
**Size:** Standard PCI half-length board

**Ordering Information**

Model	Description
7641-420	GateFlow Transceiver with two Wideband DDCs and Interpolation Filter - PCI

Contact Pentek for available options

A/D Performance

Spurious Free Dynamic Range

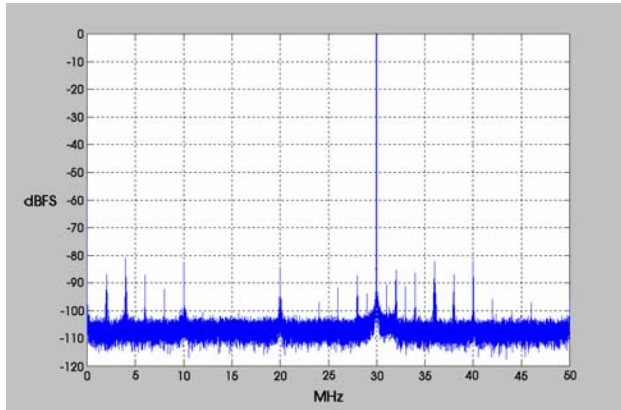

$f_{in} = 70 \text{ MHz}, f_s = 100 \text{ MHz}$

Spurious Pick-up

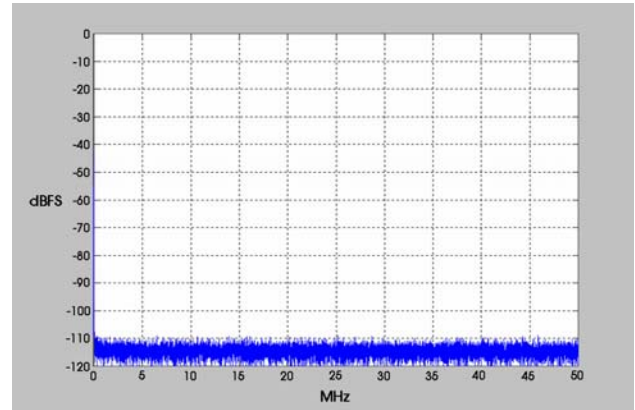

$f_s = 100 \text{ MHz}, 32k \text{ point FFT}, 8 \text{ averages}$

Input Frequency Response

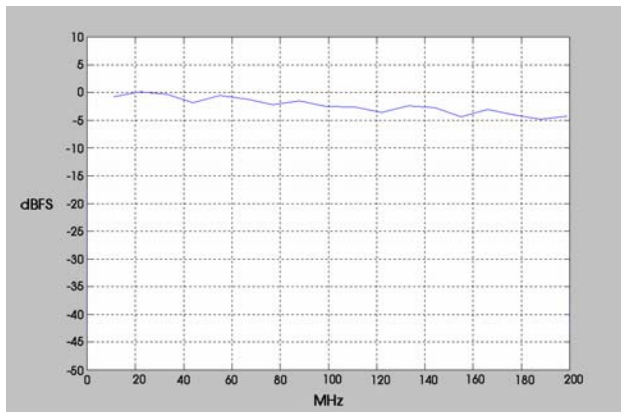

$f_s = 100 \text{ MHz}$

Two-Tone SFDR

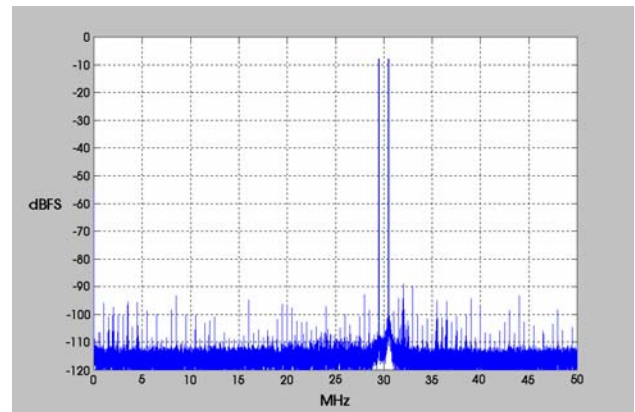

$f_1 = 29.5 \text{ MHz}, f_2 = 30.5 \text{ MHz}, f_s = 100 \text{ MHz}$

Crosstalk

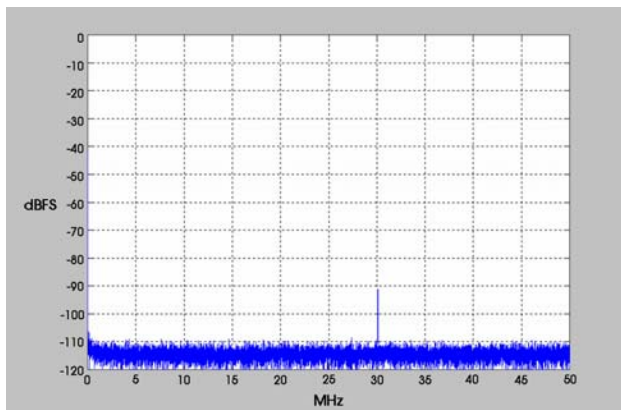

$f_{in \text{ Ch2}} = 69 \text{ MHz}, f_s = 100 \text{ MHz}, \text{ Ch 1 shown}$

Phase Noise

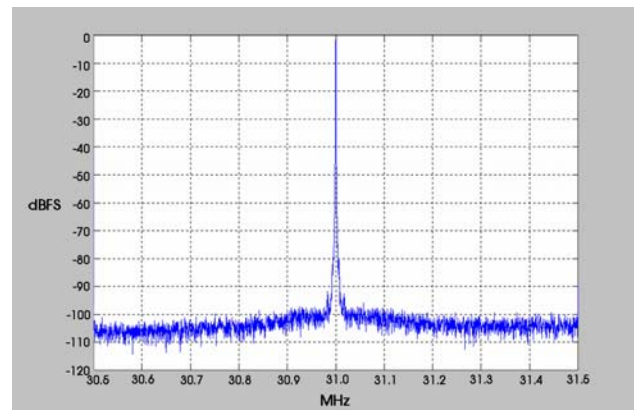

$f_{in} = 69 \text{ MHz}, f_s = 100 \text{ MHz}$   
Phase Noise @ 100 kHz =  $-102 - 10 \cdot \log(610) = -129.8 \text{ dB/Hz}$

D/A Performance

Two-Tone Intermodulation Distortion

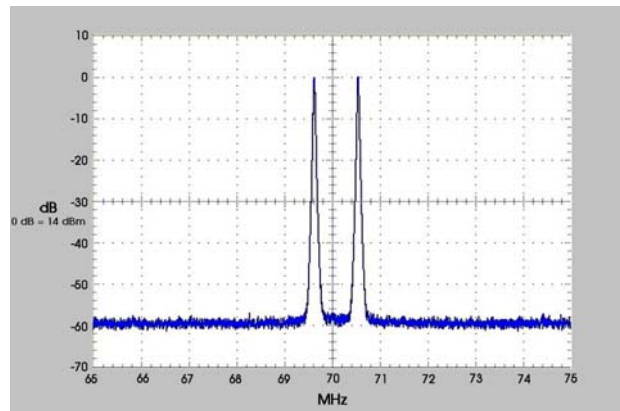

$f_1 = 69.5 \text{ MHz}$ ,  $f_2 = 70.5 \text{ MHz}$ ,  $f_s = 100 \text{ MHz}$