



Model 74620 Model 73620



### General Information

Models 72620, 73620 and 74620 are members of the Cobalt® family of high performance CompactPCI boards based on the Xilinx Virtex-6 FPGA. They consist of one or two Model 71620 XMC modules mounted on a cPCI carrier board.

Model 72620 is a 6U cPCI board while the Model 73620 is a 3U cPCI board; both are equipped with one Model 71620 XMC. Model 74620 is a 6U cPCI board with two XMC modules rather than one.

These models include three or six A/Ds, one or two DUCs, two or four D/As and four or eight banks of memory.

### The Cobalt Architecture

The Pentek Cobalt Architecture features a Virtex-6 FPGA. All of the board's data and control paths are accessible by the FPGA, enabling factory-installed functions including data multiplexing, channel selection, data packing, gating, triggering and memory control. The Cobalt Architecture organizes the FPGA as a container for data processing applications where each function exists as an intellectual property (IP) module.

Each member of the Cobalt family is delivered with factory-installed applications ideally matched to the board's analog interfaces. The factory-installed functions of these models include three or six A/D acquisition and one or two D/A waveform playback IP modules. IP modules for either DDR3 or QDRII+ memories, controllers for all data

clocking and synchronization functions, a test signal generator, and a PCIe interface complete the factory-installed functions and enable these models to operate as a complete turnkey solution, without the need to develop any FPGA IP.

### Extendable IP Design

For applications that require specialized functions, users can install their own custom IP for data processing. Pentek GateFlow FPGA Design Kits include all of the factory-installed modules as documented source code. Developers can integrate their own IP with the Pentek factory-installed functions or use the GateFlow kit to completely replace the Pentek IP with their own.

### Xilinx Virtex-6 FPGA

The Virtex-6 FPGA site can be populated with a variety of different FPGAs to match the specific requirements of the processing task. Supported FPGAs include: LX130T, LX240T, or SX315T. The SXT part features 1344 DSP48E slices and is ideal for modulation/demodulation, encoding/decoding, encryption/decryption, and channelization of the signals between transmission and reception. For applications not requiring large DSP resources, one of the lower-cost LXT FPGAs can be installed.

Option -104 provides 20 LVDS pairs between the FPGA and the J2 connector, Model 73620; J3 connector, Model 72620; J3 and J5 connectors, Model 74620. ➤

### Features

- Complete radar and software radio interface solution
- Supports Xilinx Virtex-6 LXT and SXT FPGAs
- Three or six 200 MHz 16-bit A/Ds
- One or two DUCs (digital upconverters)
- Two or four 800 MHz 16-bit D/As
- Up to 2 or 4 GB of DDR3 SDRAM; or: 32 MB or 64MB of QDRII+ SRAM
- Sample clock synchronization to an external system reference
- LVPECL clock/sync bus for multiboard synchronization
- Optional LVDS connections to the Virtex-6 FPGA for custom I/O

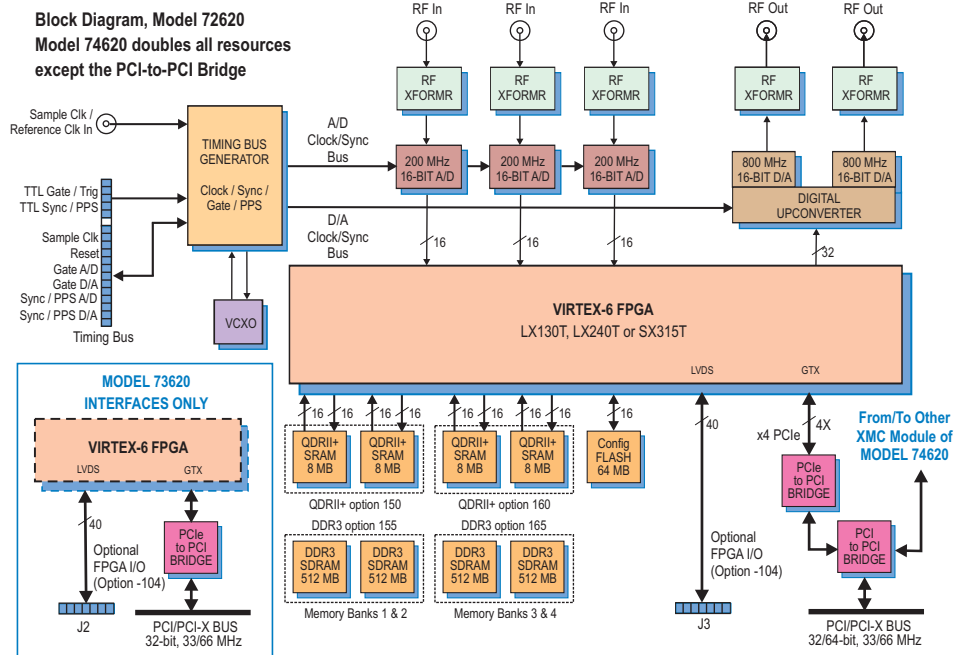

### A/D Acquisition IP Modules

These models feature three or six A/D Acquisition IP Modules for easily capturing and moving data. Each module can receive data from any of the three A/Ds, a test signal generator or from the D/A Waveform Playback IP Module in loopback mode.

Each IP module has an associated memory bank for buffering data in FIFO mode or for storing data in transient capture mode. All memory banks are supported with DMA engines for easily moving A/D data through the PCIe interface.

These powerful linked-list DMA engines are capable of a unique Acquisition Gate Driven mode. In this mode, the length of a transfer performed by a link definition need not be known prior to data acquisition; rather, it is governed by the length of the acquisition gate. This is extremely useful in applications where an external gate drives acquisition and the exact length of that gate is not known or is likely to vary.

For each transfer, the DMA engine can automatically construct metadata packets containing A/D channel ID, a sample-accurate time stamp and data length information. These actions simplify the host processor's job of identifying and executing on the data.

### D/A Waveform Playback IP Modules

These models include one or two factory-installed sophisticated D/A Waveform Playback IP modules. Linked-list controllers allow users to easily play back to the dual D/As waveforms stored in either on-board memory or off-board host memory.

Parameters including length of waveform, delay from playback trigger, waveform repetition, etc. can be programmed for each waveform.

Up to 64 or 128 individual link entries can be chained together to create complex waveforms with a minimum of programming.

### A/D Converter Stage

The front end accepts three or six full-scale analog HF or IF inputs on front panel SSMC connectors at +8 dBm into 50 ohms with transformer coupling into three or six Texas Instruments ADS5485 200 MHz, 16-bit A/D converters.

The digital outputs are delivered into the Virtex-6 FPGA for signal processing, data capture or for routing to other board resources.

### Digital Upconverter and D/A Stage

One or two TI DAC5688 DUCs (digital upconverters) and D/As accept baseband real or complex data streams from the FPGA and provide that input to the upconvert, interpolate and dual D/A stages.

When operating as a DUC, it interpolates and translates real or complex baseband input signals to any IF center frequency up to 360 MHz. It delivers real or quadrature (I+Q) analog outputs to the dual 16-bit D/A converter. Analog output is through front panel SSMC connectors.

If translation is disabled, the DAC5688 acts as a dual interpolating 16-bit D/A with output sampling rates up to 800 MHz. In both modes, the DAC5688 provides interpolation factors of 2x, 4x and 8x.

### Clocking and Synchronization

Two internal timing buses provide either a single clock or two different clock rates to the A/D and D/A signal paths.

Each timing bus includes a clock, sync and a gate or trigger signal. An on-board clock generator receives an external sample clock from the front panel SSMC connector. This clock can be used directly for either the A/D or D/A sections or can be divided by a built-in clock synthesizer circuit to provide different A/D and D/A clocks. In an alternate mode, the sample clock can be sourced from an on-board programmable VCXO (Voltage-Controlled Crystal Oscillator). In this mode, the front panel SSMC connector can be used to provide a 10 MHz reference clock for synchronizing the internal oscillator.

A front panel 26-pin LVPECL Clock/Sync connector allows multiple boards to be synchronized. In the slave mode, it accepts LVPECL inputs that drive the clock, sync and gate signals. In the master mode, the LVPECL bus can drive the timing signals for synchronizing multiple boards.

Multiple boards can be driven from the LVPECL bus master, supporting synchronous sampling and sync functions across all connected boards.

### Memory Resources

The Cobalt architecture supports up to four or eight independent memory banks which can be configured with all QDRII+ SRAM, DDR3 SDRAM, or as combination of two banks of each type of memory. ➤

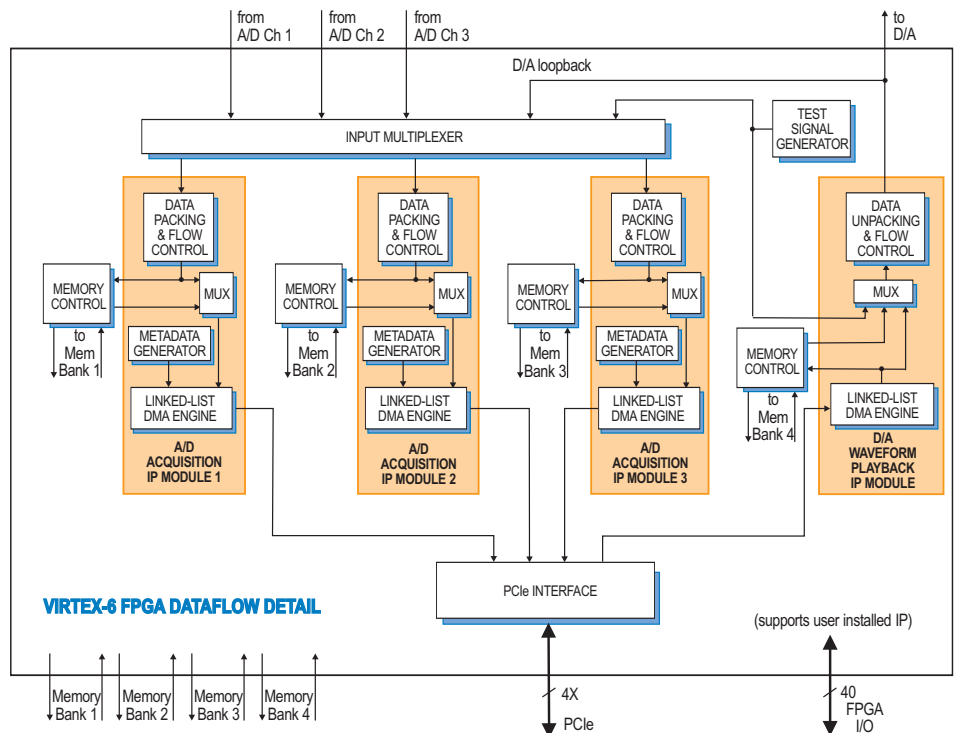

► Each QDRII+ SRAM bank can be up to 8 MB deep and is an integral part of the module's DMA capabilities, providing FIFO memory space for creating DMA packets. For applications requiring deep memory resources, DDR3 SDRAM banks can each be up to 512 MB deep. Built-in memory functions include A/D data transient capture mode and D/A waveform playback mode.

In addition to the factory-installed functions, custom user-installed IP within the FPGA can take advantage of the memories for many other purposes.

### PCI-X Interface

These models include an industry-standard interface fully compliant with PCI-X bus specifications. The interface includes multiple DMA controllers for efficient transfers to and from the board. Data widths of 32 or 64 bits and data rates of 33 and 66 MHz are supported. Model 73620: 32 bits only.

### Specifications

**Model 72620 or Model 73620: 3 A/Ds,  
1 DUC, 2 D/As**

**Model 74620: 6 A/Ds, 2 DUCs, 4 D/As**

**Front Panel Analog Signal Inputs (3 or 6)**

**Input Type:** Transformer-coupled, front panel female SSMC connectors

**Transformer Type:** Coil Craft WBC4-6TLB

**Full Scale Input:** +8 dBm into 50 ohms

**3 dB Passband:** 300 kHz to 700 MHz

**A/D Converters (3 or 6)**

**Type:** Texas Instruments ADS5485

**Sampling Rate:** 10 MHz to 200 MHz

**Resolution:** 16 bits

**D/A Converters (2 or 4)**

**Type:** Texas Instruments DAC5688

**Input Data Rate:** 250 MHz max.

**Output IF:** DC to 400 MHz max.

**Output Signal:** 2-channel real or 1-channel with frequency translation

**Output Sampling Rate:** 800 MHz max. with interpolation

**Resolution:** 16 bits

**Front Panel Analog Signal Outputs (2 or 4)**

**Output Type:** Transformer-coupled, front panel female SSMC connectors

**Transformer Type:** Coil Craft WBC4-6TLB

**Full Scale Output:** +4 dBm into 50 ohms

**3 dB Passband:** 300 kHz to 700 MHz

**Sample Clock Sources (2 or 4)**

On-board clock synthesizer generates two clocks: one A/D clock and one D/A clock

**Clock Synthesizers (1 or 2)**

**Clock Source:** Selectable from on-board programmable VCXO (10 to 810 MHz), front panel external clock or LVPECL timing bus

**Synchronization:** VCXO can be locked to an external 4 to 180 MHz PLL system reference, typically 10 MHz

**Clock Dividers:** External clock or VCXO can be divided by 1, 2, 4, 8, or 16 for the A/D clock

**External Clocks (1 or 2)**

**Type:** Front panel female SSMC connector, sine wave, 0 to +10 dBm, AC-coupled, 50 ohms, accepts 10 to 800 MHz sample clock or PLL system reference

**Timing Bus (1 or 2):** 26-pin connector

LVPECL bus includes, clock/sync/gate/PPS inputs and outputs; TTL signal for gate/trigger and sync/PPS inputs

**Field Programmable Gate Arrays (1 or 2)**

**Standard:** Xilinx Virtex-6 XC6VLX130T

**Optional:** Xilinx Virtex-6 XC6VLX240T or XC6VSX315T

**Custom I/O**

**Option -104:** Provides 20 LVDS pairs between the FPGA and the J2 connector, Model 73620; J3 connector, Model 72620; J3 and J5 connectors, Model 74620

**Memory Banks (1 or 2)**

**Option 150 or 160:** Two 8 MB QDRII+ SRAM memory banks, 400 MHz DDR

**Option 155 or 165:** Two 512 MB DDR3 SDRAM memory banks, 400 MHz DDR

**PCI-X Interface**

**PCI-X Bus:** 32 or 64 bits at 33 or 66 MHz  
Model 73620: 32 bits only

**Environmental**

**Operating Temp:** 0° to 50° C

**Storage Temp:** -20° to 90° C

**Relative Humidity:** 0 to 95%, non-cond.

**Size:** Standard 6U or 3U cPCI board

### Ordering Information

Model	Description
72620	3-Channel 200 MHz A/D and 2-Channel 800 MHz D/A with Virtex-6 FPGA - 6U cPCI
73620	3-Channel 200 MHz A/D and 2-Channel 800 MHz D/A with Virtex-6 FPGA - 3U cPCI
74620	6-Channel 200 MHz A/D and 4-Channel 800 MHz D/A and two Virtex-6 FPGAs - 6U cPCI
<b>Options:</b>	
-062	XC6VLX240T FPGA
-064	XC6VSX315T FPGA
-104	LVDS I/O between the FPGA and J2 connector, Model 73620; J3 connector, Model 72620; J3 and J5 connectors, Model 74620
-150	Two 8 MB QDRII+ SRAM Memory Banks (Banks 1 and 2)
-160	Two 8 MB QDRII+ SRAM Memory Banks (Banks 3 and 4)
-155	Two 512 MB DDR3 SDRAM Memory Banks (Banks 1 and 2)
-165	Two 512 MB DDR3 SDRAM Memory Banks (Banks 3 and 4)

A/D Performance

Spurious Free Dynamic Range

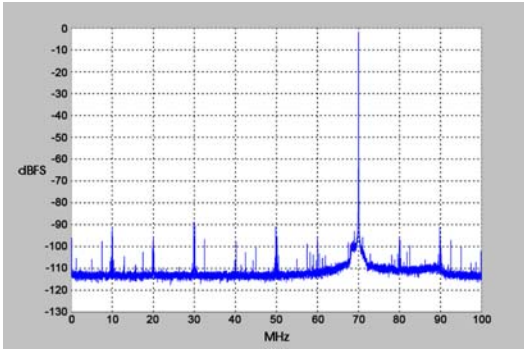

$f_{in} = 70 \text{ MHz}$ ,  $f_s = 200 \text{ MHz}$ , Internal Clock

Spurious Pick-up

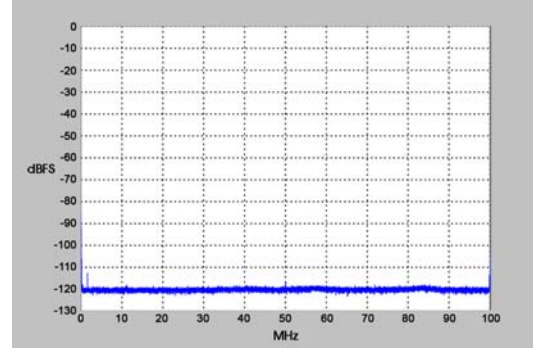

$f_s = 200 \text{ MHz}$ , Internal Clock

Two-Tone SFDR

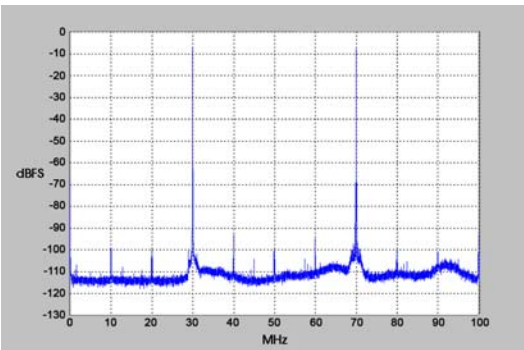

$f_1 = 30 \text{ MHz}$ ,  $f_2 = 70 \text{ MHz}$ ,  $f_s = 200 \text{ MHz}$

Two-Tone SFDR

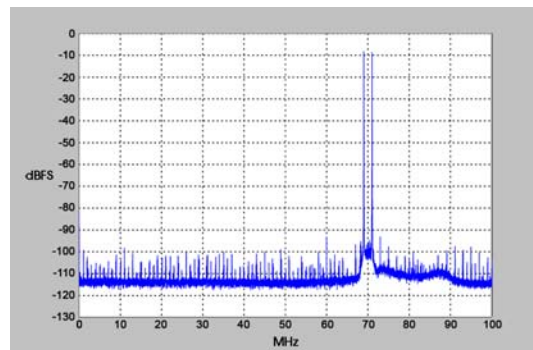

$f_1 = 69 \text{ MHz}$ ,  $f_2 = 71 \text{ MHz}$ ,  $f_s = 200 \text{ MHz}$

Adjacent Channel Crosstalk

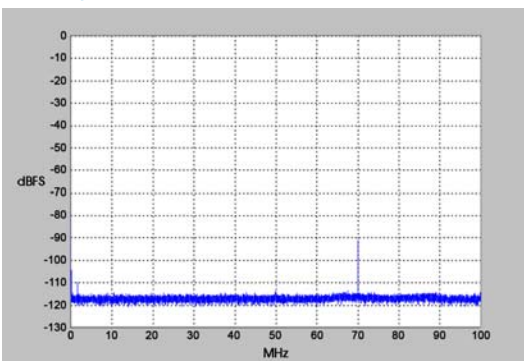

$f_{in \text{ Ch2}} = 70 \text{ MHz}$ ,  $f_s = 200 \text{ MHz}$ , Ch 1 shown

Input Frequency Response

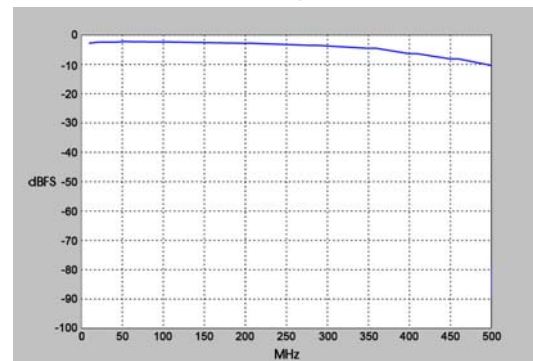

$f_s = 200 \text{ MHz}$ , Internal Clock

Spurious Free Dynamic Range

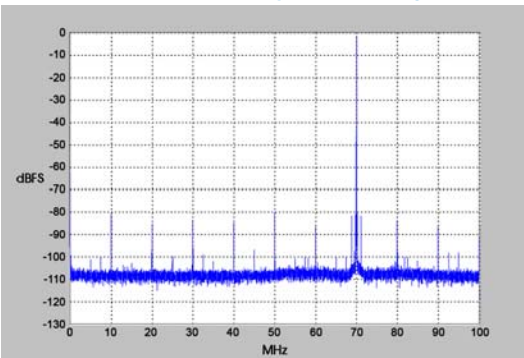

$f_{out} = 70 \text{ MHz}$ ,  $f_s = 200 \text{ MHz}$ , Internal Clock

D/A Performance

Spurious Free Dynamic Range

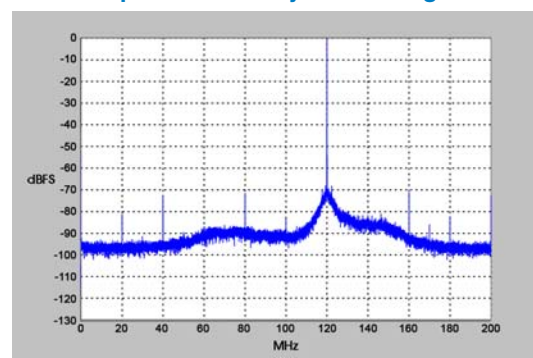

$f_{out} = 140 \text{ MHz}$ ,  $f_s = 400 \text{ MHz}$ , External Clock