



Features

- Complete software radio transceiver solution
- GateFlow Core 430 with 256 Channels of Narrowband Digital Downconverters factory-installed
- 256 fully programmable NCOs with 32-bit frequency tuning resolution
- Programmable decimation settings from 1024 to 9984 in steps of 256
- **Conduction-cooled version available with Model 7141-703**

General Information

Model 7141-430, Dual Digital Transceiver with 256-Channel Narrowband DDC Core 430, is a complete software radio system in a PMC/XMC module. It includes two A/D and two D/A converters for connection to HF or IF ports of a communications or radar system.

The 7141 receiver section features two LTC2255 125 MHz 14-bit A/D converters and one Texas Instruments GC4016 quad multiband digital downconverter. The GC4016 supports a decimation range from 32 to 16,384. For an A/D sample clock frequency of 100 MHz, the output bandwidth for each of the four channel ranges from 2.5 MHz down to 5 kHz. By combining two or four channels, decimations of 16 or 8 can be achieved for an output bandwidth of up to 5 or 10 MHz, respectively.

For applications that require many channels of narrowband downconverters, Pentek offers the GateFlow IP Core 430 256-Channel Digital Downconverter bank. Factory installed in the 7141-430 FPGA, Core 430 creates a flexible, very high channel count receiver system in a small footprint.

Core 430: 256-Channel DDC Bank

Unlike legacy channelizer methods, the Pentek 430 core allows for independent programmable tuning of each channel with 32-bit resolution. Filter characteristics are comparable to many conventional ASIC DDCs.

Added flexibility comes from programmable global decimation settings ranging from 1024 to 9984 in steps of 256, and 18-bit user programmable FIR decimating filter coefficients for the DDCs. Default DDC filter coefficient sets are included with the core for all possible decimation settings.

Core 430 utilizes a unique method of channelization. It differs from others in that the channel center frequencies need not be at fixed intervals, and are independently programmable to any value.

Performance Parameter	Value
Input Data Resolution	16-bit
Output Data Resolution	16-bit Complex
Tuning Resolution	Clock Freq / 2 ³²
Decimation	1024 – 9984 in steps of 256
Passband Ripple	<0.4 dB with default filter coefficients
Usable Bandwidth	80% with default filter coefficients
Stopband Attenuation	>75 dB
NCO SFDR	>110 dB

Flexible Architecture

Core 430 DDC comes factory-installed in the Model 7141-430. A multiplexer in front of the core allows data to be sourced from either A/D converter, A or B. At the output, a multiplexer allows for routing either the output of the GC4016 or the Core 430 DDC to the PCI Bus.

In addition to the DDC outputs, data from both A/D channels are presented to the PCI Bus at a rate equal to the A/D clock rate divided by any interger value between 1 and 4096. A Texas Instruments DAC5686 digital upconverter and dual D/A accepts baseband real or complex data streams from the PCI Bus with signal bandwidths up to 50 MHz. The analog outputs are transformer-coupled to front panel MMCX connectors. ➤

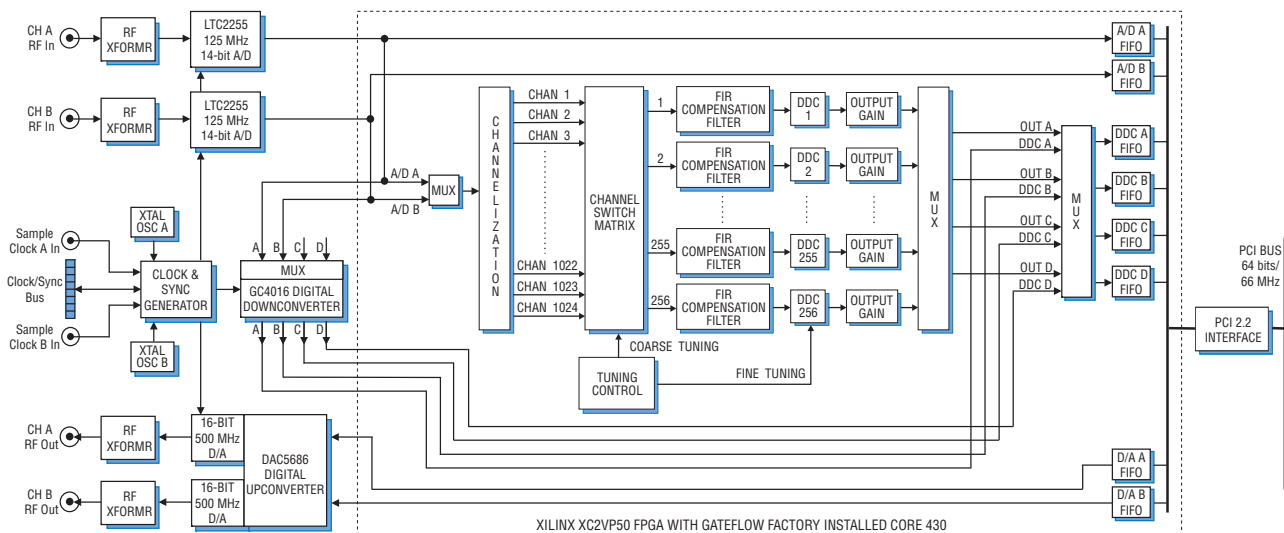

XMC Interface

Model 7141-430 complies with the VITA 42.0 XMC specification for carrier boards. This emerging standard provides, among others, for a 4X link with a 3.125 GHz bit clock between the XMC module and the carrier board. With two 4X links, the 7141-430 achieves 2.5 GB/sec streaming data transfer rate independent of the PCI interface and supports switched fabric protocols such as Serial RapidIO and PCI Express.

► Clocking and Synchronization

Two independent internal timing buses can provide either a single clock or two different clock rates for the input and output signals.

Each timing bus includes a clock, a sync, and a gate or trigger signal. Signals from either Timing Bus A or B can be selected as the timing source for the A/Ds, the downconverter, the upconverter and the D/As.

Two external reference clocks are accepted, one for each timing bus and two internal clocks may be used for each timing bus.

A front panel 26-pin LVDS Clock/Sync connector allows multiple modules to be synchronized. In the slave mode, it accepts differential LVDS inputs that drive the clock, sync and gate signals for the two internal timing buses.

In the master mode, the LVDS bus can drive one or both sets of timing signals from the two internal timing buses for synchronizing multiple modules.

Up to seven slave 7141-430's, can be driven from the LVDS bus master, supporting synchronous sampling and sync functions across all connected modules. Up to 80 modules may be synchronized with a Model 9190 Clock and Sync Generator.

Memory Resources

Three independent banks of SDRAM are available to the FPGA. Built-in memory functions include an A/D data transient capture mode with pre- and post-triggering; a D/A waveform generator mode; and an A/D data delay mode for applications such as tracking receivers.

PCI Interface

Model 7141-430 includes an industry-standard interface fully compliant with PCI 2.2 bus specifications. The interface includes nine separate DMA controllers for efficient transfers to and from the module. Data widths of 32 or 64 bits and data rates of 33 or 66 MHz are supported.

Specifications

Analog Signal Inputs

Input Type: Transformer-coupled, front panel female MMCX connectors

Transformer Type: Coil Craft WBC1-1TLB

Full Scale Input: +10 dBm into 50 ohms
3 dB Passband: 250 kHz to 300 MHz

A/D Converters

Type: Linear Technology LTC2255

Sampling Rate: 1 MHz to 125 MHz

Internal Clock: Crystal oscillator A or B

External Clock: 1 to 125 MHz

Resolution: 14 bits

Digital Downconverter

Type: TI/Graychip GC4016

Decimation: 32 to 16,384; with channel combining mode: 8 or 16

Data Source: A/D, FPGA, or PCI interface

Control Source: FPGA or PCI interface

Output: Parallel complex data

Receiver Bypass Mode: Data from the A/Ds can be written directly into the FPGAs at a rate equal to the A/D clock decimated by any integer between 1 and 4096

Front Panel Analog Signal Outputs

Output Type: Transformer-coupled, front panel female MMCX connectors

Full Scale Output: +4 dBm into 50 ohms
3 dB Passband: 60 kHz to 300 MHz

Digital Upconverter

Type: TI DAC5686

Input Bandwidth: 40 MHz, max.

Output IF: DC to 160 MHz

Output Signal: Analog, real or quadrature
Sampling Rate: 320 MHz, max; 500 MHz max. with upconversion disabled

Resolution: 16 bits

Clock Sources: Selectable from onboard A or B crystal oscillators, external or LVDS clocks

External Clocks

Type: Front panel female MMCX connector, sine wave, 0 to +10 dBm, AC-coupled, 50 ohms

Sync/Gate Bus: 26-pin connector, dual clock/sync/gate input/output LVDS buses; one sync/gate input TTL signal

Field Programmable Gate Array

Type: Xilinx Virtex-II Pro XC2VP50

Memory

DDR SDRAM: 512 MB in three banks

PCI Interface

PCI Bus: 64-bit, 66 MHz (also supports 32-bit and/or 33 MHz)

Local Bus: 64-bit, 66 MHz

DMA: 9 channel demand-mode and chaining controller

Environmental (Commercial version)

Operating Temp: 0° to 50° C

Storage Temp: -20° to 90° C

Relative Humidity: 0 to 95%, non-cond.

Size: Standard PMC module, 2.91 in. x 5.87 in.

Ordering Information

Model	Description
7141-430	GateFlow Transceiver with 256-Channel Narrowband DDC Core factory installed - PMC/XMC

Contact Pentek for available options

A/D Performance

Spurious Free Dynamic Range

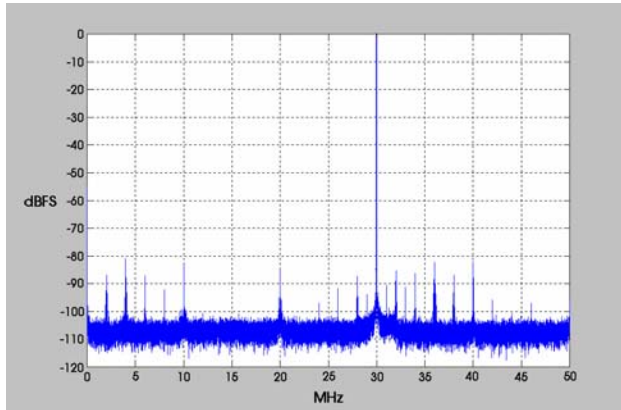

$f_{in} = 70 \text{ MHz}, f_s = 100 \text{ MHz}$

Spurious Pick-up

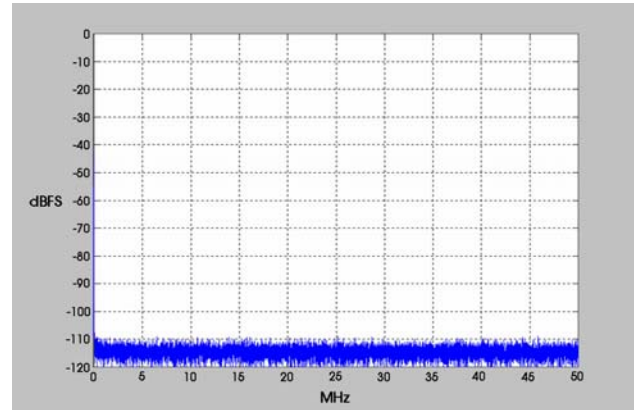

$f_s = 100 \text{ MHz}, 32k \text{ point FFT}, 8 \text{ averages}$

Input Frequency Response

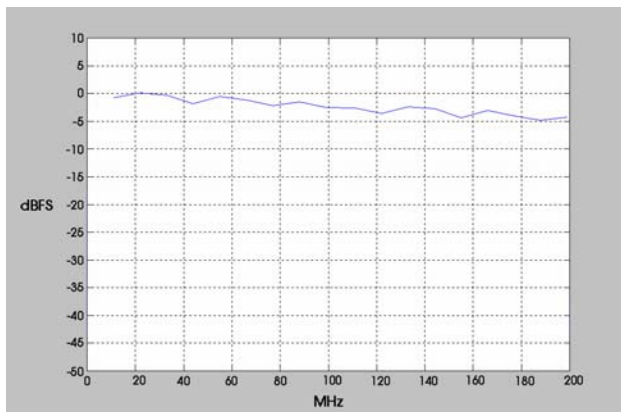

$f_s = 100 \text{ MHz}$

Two-Tone SFDR

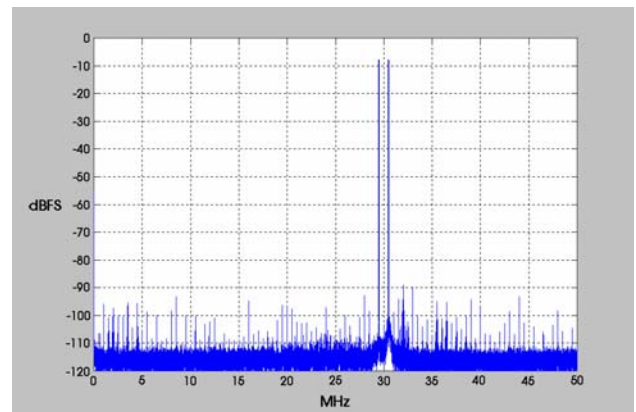

$f_1 = 29.5 \text{ MHz}, f_2 = 30.5 \text{ MHz}, f_s = 100 \text{ MHz}$

Crosstalk

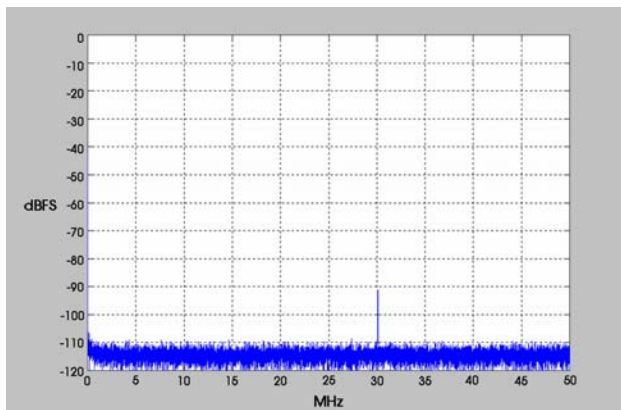

$f_{in \text{ Ch2}} = 69 \text{ MHz}, f_s = 100 \text{ MHz}, \text{ Ch 1 shown}$

Phase Noise

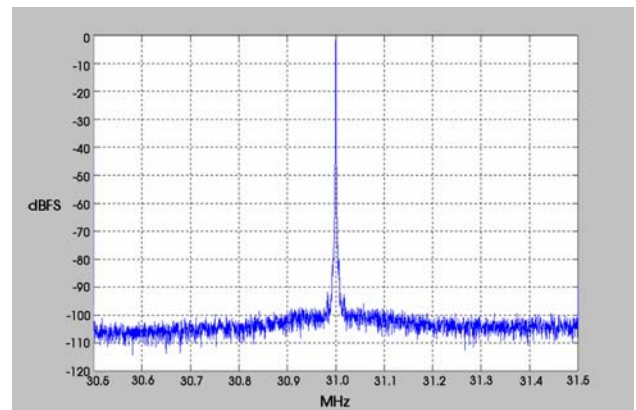

$f_{in} = 69 \text{ MHz}, f_s = 100 \text{ MHz}$
Phase Noise @ 100 kHz = $-102 - 10 \cdot \log(610) = -129.8 \text{ dB/Hz}$

D/A Performance

Two-Tone Intermodulation Distortion

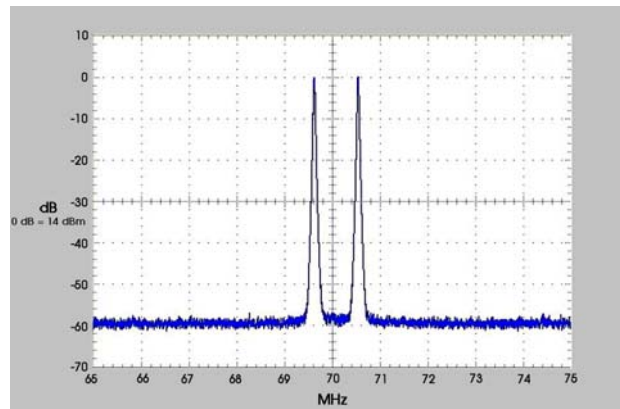

$f_1 = 69.5 \text{ MHz}$, $f_2 = 70.5 \text{ MHz}$, $f_s = 100 \text{ MHz}$