

New!



Commercial version shown; ruggedized and conduction-cooled versions also available.



Features

- Complete software radio transceiver solutions
- VITA 42.0 XMC compatible with switched fabric interfaces
- Two 125 MHz 14-bit A/Ds
- Input signal bandwidth: 50 MHz
- Four digital downconverters
- One digital upconverter
- Two 500 MHz 16-bit D/As
- 512 MB of DDR SDRAM
- Xilinx Virtex-II Pro FPGA
- Up to 1.28 seconds of delay or data capture at 100 MHz
- Dual timing buses for independent input and output clock rates
- LVDS clock/sync bus for multi-module synchronization
- 32 pairs of LVDS connections to the Virtex-II Pro FPGA for custom I/O on P4
- Optional factory-installed IP Cores available
- Ruggedized and conduction-cooled versions available

General Information

Model 7141 is a software radio transceiver suitable for connection to HF or IF ports of a communications system. It includes two A/D and two D/A converters capable of bandwidths to 50 MHz and above. The 7141 uses the popular PMC format and supports the emerging VITA 42 XMC standard with optional switched fabric interfaces.

A/D Converter Stage

The front end accepts two full scale analog HF or IF inputs on front panel MMCX connectors at +10 dBm into 50 ohms with transformer coupling for the LTC2255 14-bit 125MHz A/Ds.

The digital outputs are delivered into the Virtex-II Pro FPGA for signal processing or for routing to other module resources.

Digital Downconverter Stage

A TI/Graychip GC4016 quad digital downconverter accepts either four 14-bit inputs or three 16-bit digital inputs from the FPGA, which determines the source of GC4016 input data. These sources include the A/D converters, FPGA signal processing engines, SDRAM delay memory and data sources on the PCI bus.

Each GC4016 channel may be set for independent tuning frequency and bandwidth. For an A/D sample clock frequency of 100 MHz, the output bandwidth for each channel ranges from 5 kHz up to 2.5 MHz. By combining two or four channels, output bandwidth of up to 5 or 10 MHz can be achieved.

Digital Upconverter Stage

A TI DAC5686 digital upconverter (DUC) and dual D/A accepts baseband real or complex data streams from the FPGA with signal bandwidths up to 40 MHz.

When operating as an upconverter, it interpolates and translates real or complex baseband input signals to any IF center frequency between DC and 160 MHz. It delivers real or quadrature (I+Q) analog outputs through two 320 MHz 16-bit D/A converters to two front panel MMCX connectors at +4 dBm into 50 ohms.

If translation is disabled, the DAC5686 acts as a two channel interpolating 16-bit D/A with output sampling rates up to 500 MHz.

Virtex-II Pro FPGA

The Xilinx XC2VP50 Virtex-II Pro FPGA serves as a control and status engine with data and programming interfaces to each of the on-board resources including the A/D converters, GC4016 digital downconverter, digital upconverter and D/A converters.

Factory installed FPGA functions include data multiplexing, channel selection, data packing, gating, triggering and SDRAM memory control.

Option -104 adds the P4 PMC connector with 32 pairs of LVDS connections to the Virtex-II Pro FPGA for custom I/O.

The FPGA includes two PowerPC cores which can be used as local microcontrollers to create complete application engines.

Clocking and Synchronization

Two independent internal timing buses can provide either a single clock or two different clock rates for the input and output signals.

Each timing bus includes a clock, a sync, and a gate or trigger signal. Signals from either Timing Bus A or B can be selected as the timing source for the A/Ds, the downconverter, the upconverter and the D/As.

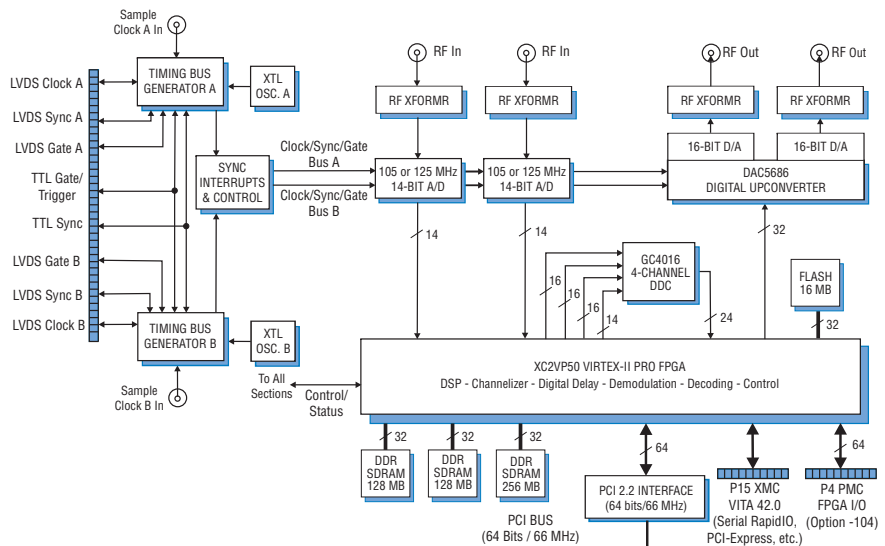

XMC Interface

Model 7141 complies with the VITA 42.0 XMC specification for carrier boards. This emerging standard provides, among others, for a 4X link with a 3.125 GHz bit clock between the XMC module and the carrier board. With two 4X links, the 7141 achieves 2.5 GB/sec streaming data transfer rate independent of the PCI interface and supports switched fabric protocols such as Serial RapidIO and PCI Express.

► Two external reference clocks are accepted, one for each timing bus and two internal clocks may be used for each timing bus.

A front panel 26-pin LVDS Clock/Sync connector allows multiple modules to be synchronized. In the slave mode, it accepts differential LVDS inputs that drive the clock, sync and gate signals for the two internal timing buses.

In the master mode, the LVDS bus can drive one or both sets of timing signals from the two internal timing buses for synchronizing multiple modules.

Up to seven slave 7141's, can be driven from the LVDS bus master, supporting synchronous sampling and sync functions across all connected boards. Up to 80 modules may be synchronized with a Model 9190 Clock and Sync Generator.

Memory Resources

Three independent banks of SDRAM are available to the FPGA. Built-in memory functions include an A/D data transient capture mode with pre- and post-triggering; a D/A waveform generator mode; and an A/D data delay mode for applications such as tracking receivers.

The SDRAMs are also available as a resource for the two PowerPC processor cores within the FPGA. A 16 MB FLASH memory supports booting and program store for these processors.

PCI Interface

Model 7141 includes an industry-standard interface fully compliant with PCI 2.2 bus specifications. The interface includes nine separate DMA controllers for efficient transfers to and from the module. Data widths of 32 or 64 bits and data rates of 33 or 66 MHz are supported.

Specifications

Analog Signal Inputs

Input Type: Transformer-coupled, front panel female MMCX connectors

Transformer Type: Coil Craft WBC1-1TLB

Full Scale Input: +10 dBm into 50 ohms
3 dB Passband: 250 kHz to 300 MHz

A/D Converters

Type: Linear Technology LTC2255

Sampling Rate: 1 MHz to 125 MHz

Internal Clock: Crystal oscillator A or B

External Clock: 1 to 125 MHz

Resolution: 14 bits

Digital Downconverter

Type: TI/Graychip GC4016

Decimation: 32 to 16,384; with channel combining mode: 8 or 16

Data Source: A/D, FPGA, or PCI interface

Control Source: FPGA or PCI interface

Output: Parallel complex data

Receiver Bypass Mode: Data from the A/Ds can be written directly into the FPGAs at a rate equal to the A/D clock decimated by any integer between 1 and 4096

Front Panel Analog Signal Outputs

Output Type: Transformer-coupled, front panel female MMCX connectors

Full Scale Output: +4 dBm into 50 ohms

Option -002: -2 dBm into 50 ohms

3 dB Passband: 60 kHz to 300 MHz

Option -002: 400 kHz to 800 MHz

Digital Upconverter

Type: TI DAC5686

Input Bandwidth: 40 MHz, max.

Output IF: DC to 160 MHz

Output Signal: Analog, real or quadrature

Sampling Rate: 320 MHz, max; 500 MHz max. with upconversion disabled

Resolution: 16 bits

Clock Sources: Selectable from onboard A or B crystal oscillators, external or LVDS clocks

External Clocks

Type: Front panel female MMCX connector, sine wave, 0 to +10 dBm, AC-coupled, 50 ohms

Sync/Gate Bus: 26-pin connector, dual clock/sync/gate input/output LVDS buses; one sync/gate input TTL signal

Field Programmable Gate Array

Type: Xilinx Virtex-II Pro

Option -050: XC2VP50

Option -104: Installs P4 connector with 64 lines to the XC2VP50 FPGA

Memory

DDR SDRAM: 512 MB in three banks

FLASH: One bank of 16 MB.

PCI Interface

PCI Bus: 64-bit, 66 MHz (also supports 32-bit and/or 33 MHz)

Local Bus: 64-bit, 66 MHz

DMA: 9 channel demand-mode and chaining controller

Environmental (Commercial version)

Operating Temp: 0° to 50° C

Storage Temp: -20° to 90° C

Relative Humidity: 0 to 95%, non-cond.

Size: Standard PMC module, 2.91 in. x 5.87 in.

Ordering Information

Model	Description
7141	Dual Multiband Transceiver with FPGA - PMC/XMC

Options:

-002	Full-scale output: -2 dBm into 50 ohms; 3 dB passband: 400 kHz to 800 MHz
-050	XC2VP50 Virtex-II Pro FPGA
-100	100 MHz Bus A and Bus B oscillators
-101	TI DAC5687 replaces the TI DAC5686
-104	FPGA I/O through P4 connector
-125	125 MHz Bus A and 100 MHz Bus B internal oscillators
-420	Dual wideband DDC and digital interpolation filter cores, factory-installed
-430	256-channel narrowband DDC core, factory-installed
-5xx	XMC interface
-70x	Ruggedized & conduction-cooled versions

A/D Performance

Spurious Free Dynamic Range

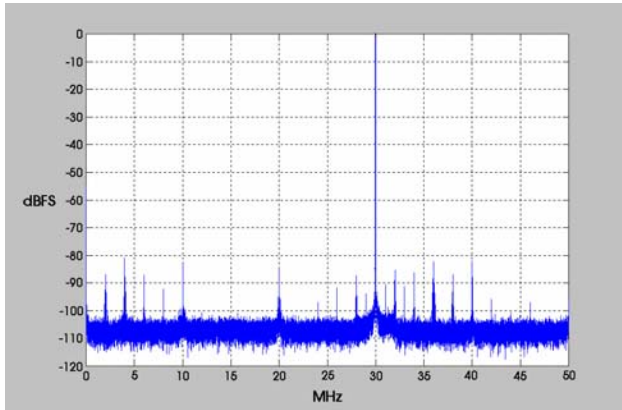

$f_{in} = 70 \text{ MHz}, f_s = 100 \text{ MHz}$

Spurious Pick-up

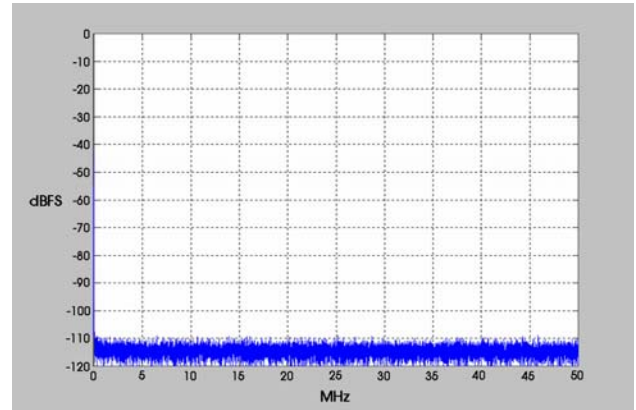

$f_s = 100 \text{ MHz}, 32k \text{ point FFT}, 8 \text{ averages}$

Input Frequency Response

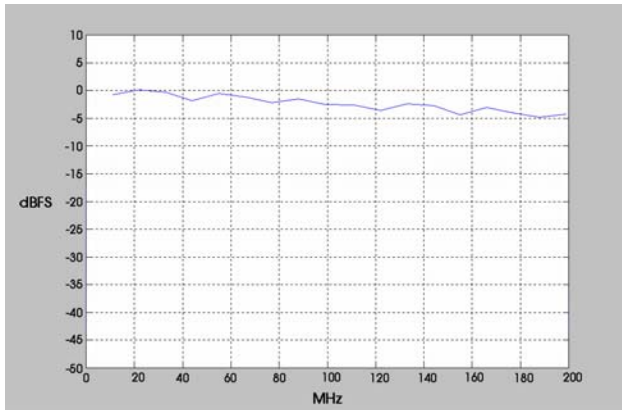

$f_s = 100 \text{ MHz}$

Two-Tone SFDR

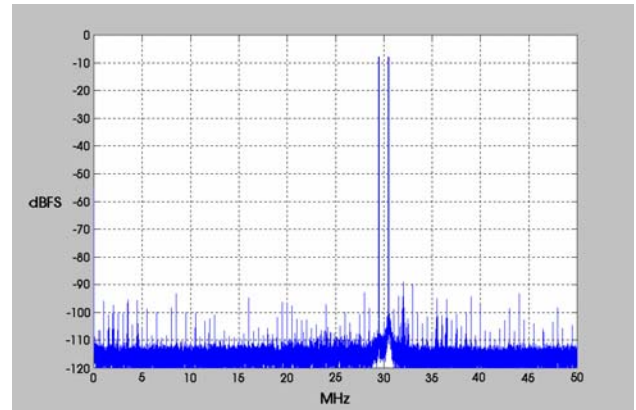

$f_1 = 29.5 \text{ MHz}, f_2 = 30.5 \text{ MHz}, f_s = 100 \text{ MHz}$

Crosstalk

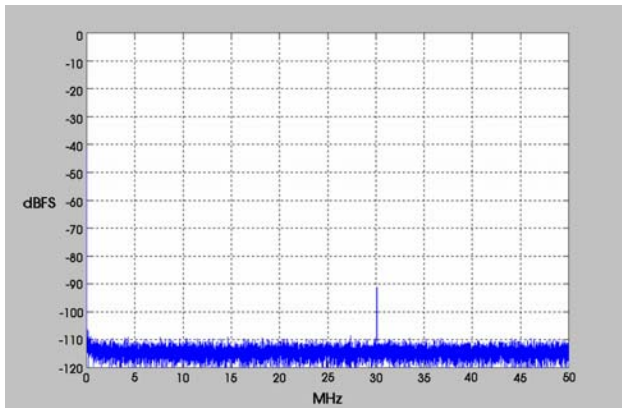

$f_{in \text{ Ch2}} = 69 \text{ MHz}, f_s = 100 \text{ MHz}, \text{ Ch 1 shown}$

Phase Noise

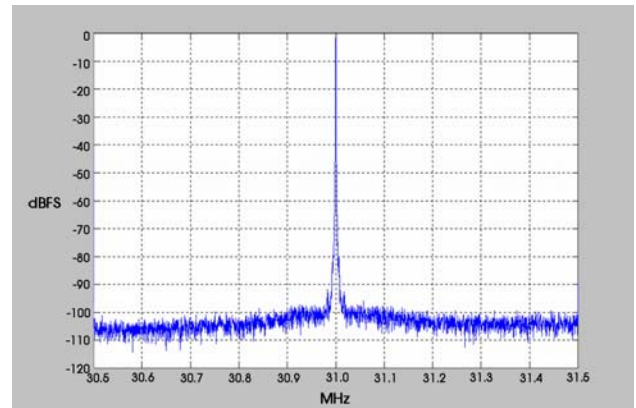

$f_{in} = 69 \text{ MHz}, f_s = 100 \text{ MHz}$
Phase Noise @ 100 kHz = $-102 - 10 \cdot \log(610) = -129.8 \text{ dB/Hz}$

D/A Performance

Two-Tone Intermodulation Distortion

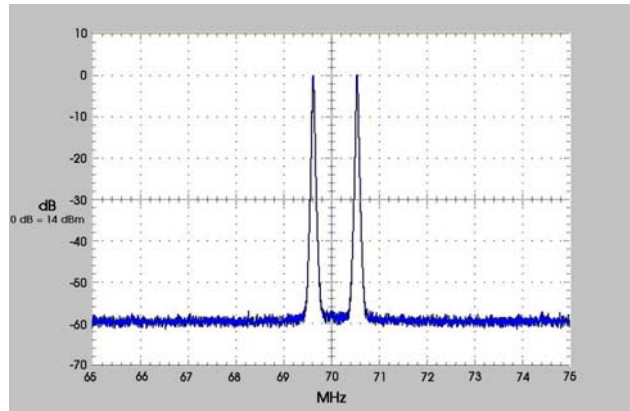

$f_1 = 69.5 \text{ MHz}$, $f_2 = 70.5 \text{ MHz}$, $f_s = 100 \text{ MHz}$